

NOOKI

LUXO|Baby

Solid Timber Cot with Storage



Assembly requires at least 2 persons



Extra tools you may need

We recommend the use of a power drill on a low-speed setting for quick assembly.



THANK YOU FOR YOUR PURCHASE!

We hope you enjoy this product as much as we enjoyed making it! We suggest you spend **5 minutes in reading these tips** before assembling the unit. Strictly follow the instructions step by step.

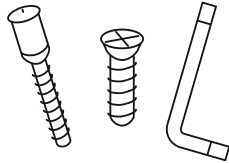

Tool Check

Check contents to ensure that you have the specified quantity for all identified parts and metal fittings.

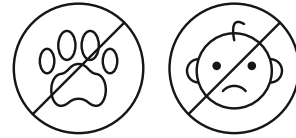

Safety Check

Keep children and pets away from working area as unit has small parts that are choking hazards if swallowed.

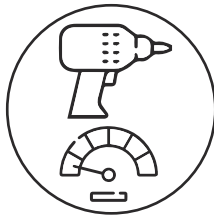

Use of Power Tool

We recommend the use of a power drill on a low-speed setting for quick assembly.

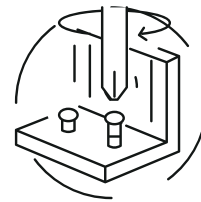

Easier Assembly Tip

We strongly advise that all fittings be finger-tightened during the initial assembly phase. You may fully tighten them all once assembly is complete.

HARDWARE LIST

Please check if you have all the fittings and tools listed below.

(A)

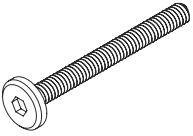

M6x60mm BOLT
4 PCS

(B)

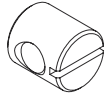

NUT
12 PCS

(C)

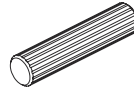

Ø 8x30mm DOWEL
18 PCS

(D)

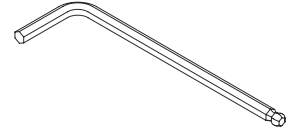

ALLEN KEY
1 PC

(E)



Left or Right
SLIDE RAIL
8 PCS

(F)



Left or Right
SLIDE RAIL
8 PCS

(G)

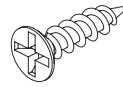

Ø 3.5x14mm SCREW
48PCS

(H)

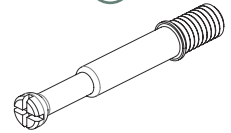

HAT SCREW
36 PCS

(J)



ECCENTRIC HAT
36 PCS

(K)

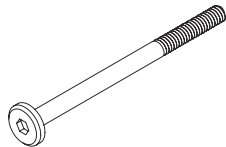

M6x90mm BOLT
8 PCS

(L)

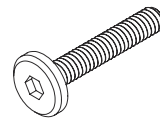

M6x35mm BOLT
4 PCS

(M)

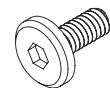

M6x15mm BOLT
4 PCS

(N)

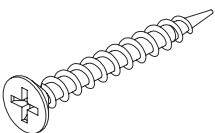

Ø 4x35mm SCREW
16PCS

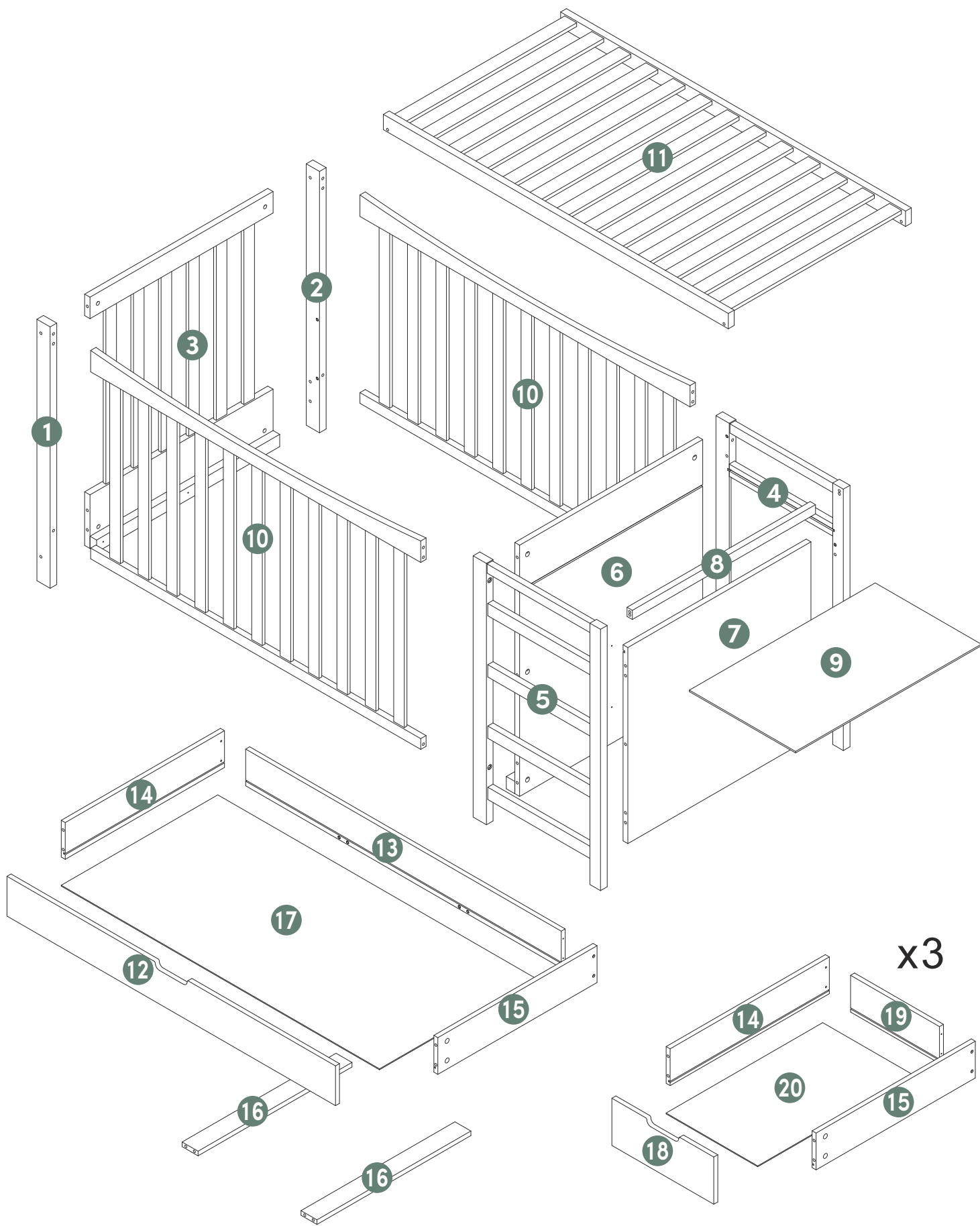

PARTS LIST



1 x1



2 x1

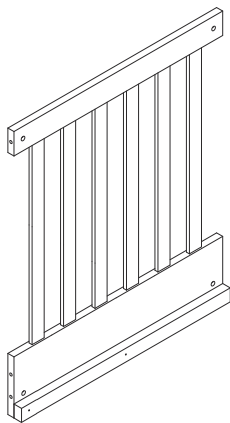

3 x1

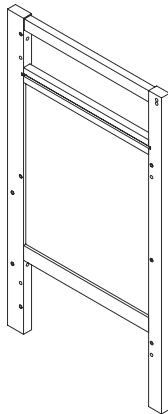

4 x1

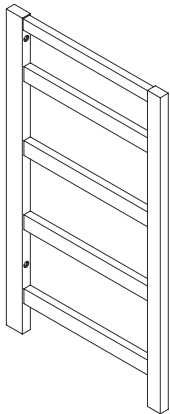

5 x1

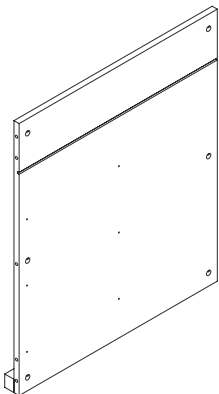

6 x1

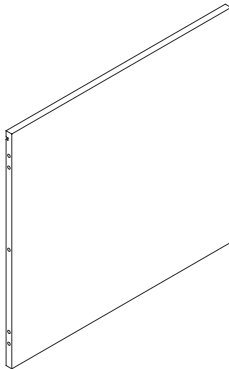

7 x1

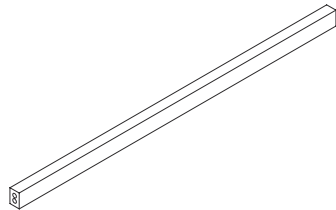

8 x1

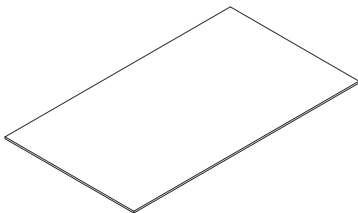

9 x1

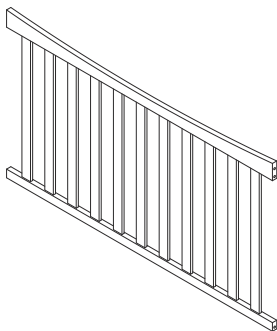

10 x2

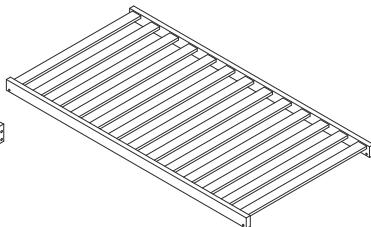

11 x1

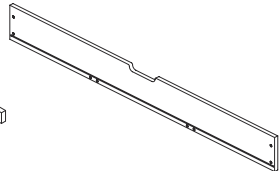

12 x1

PARTS LIST

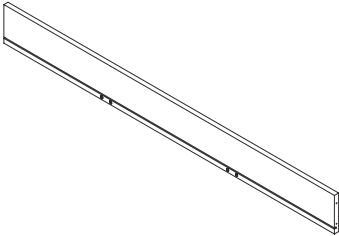

13 x1

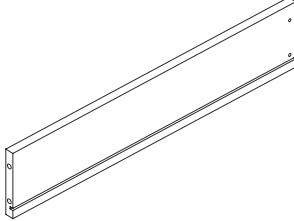

14 x4

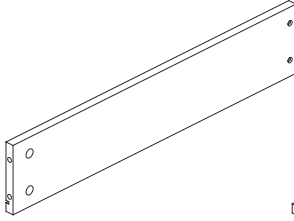

15 x4

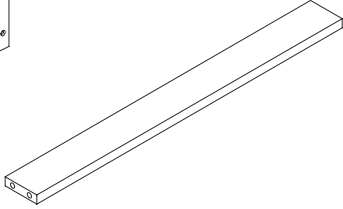

16 x2

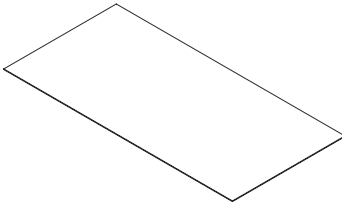

17 x1

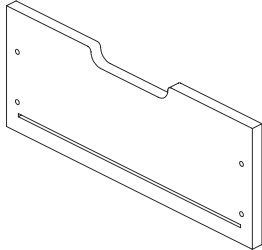

18 x3

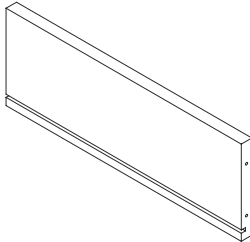

19 x3

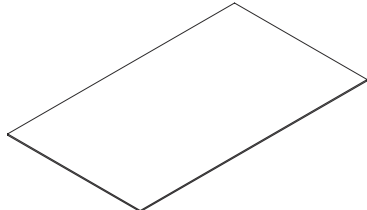



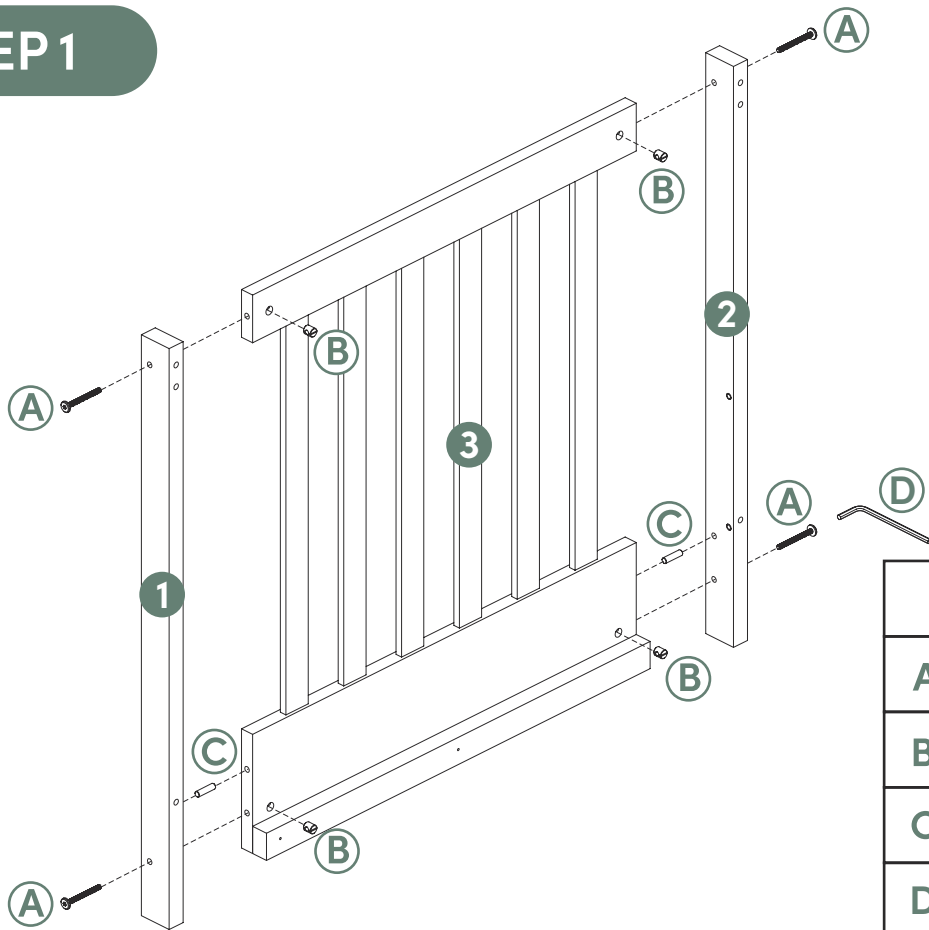

20 x3

STEP 1





YOU WILL NEED

A		x4
B		x4
C		x2
D		x1

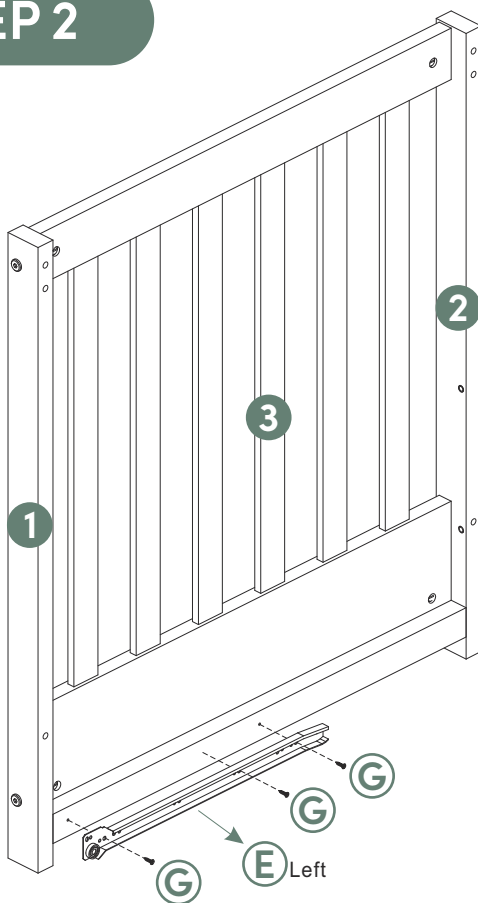
STEP 2







YOU WILL NEED

E		x1
G		x3

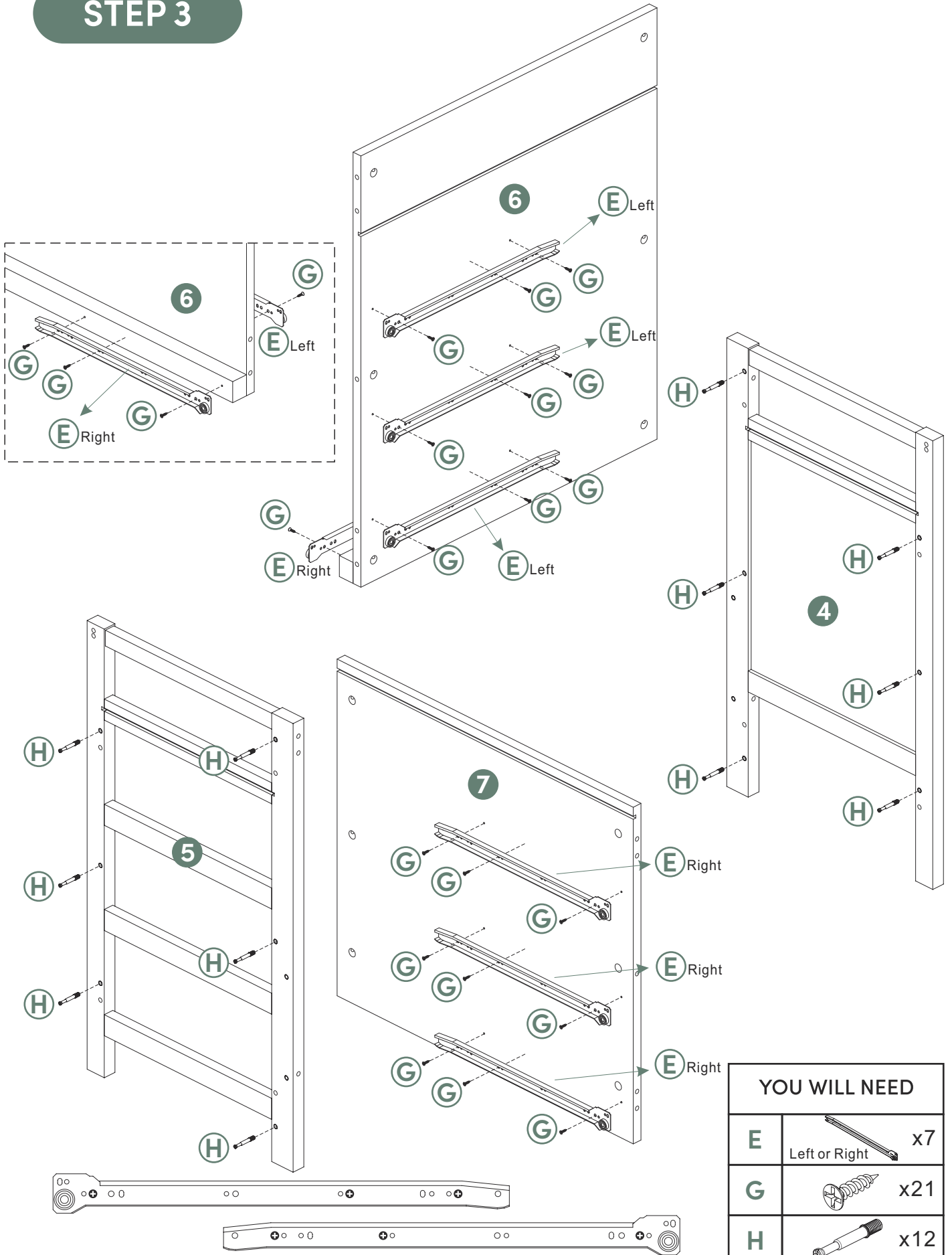
ASSEMBLY STEPS

STEP 3





YOU WILL NEED		
E		x7
G		x21
H		x12

ASSEMBLY STEPS

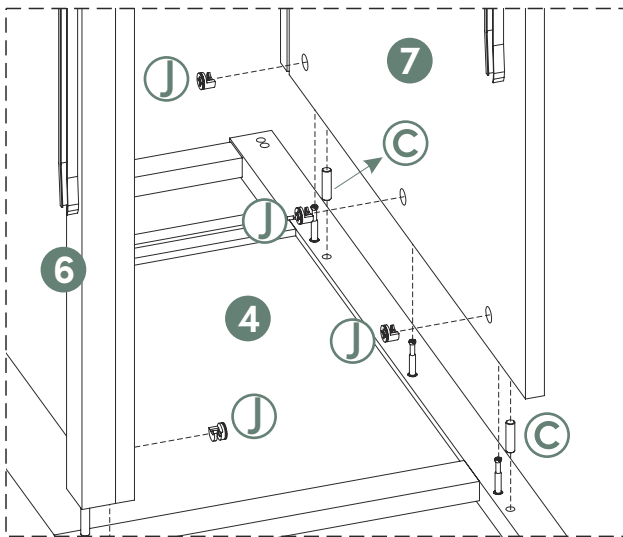
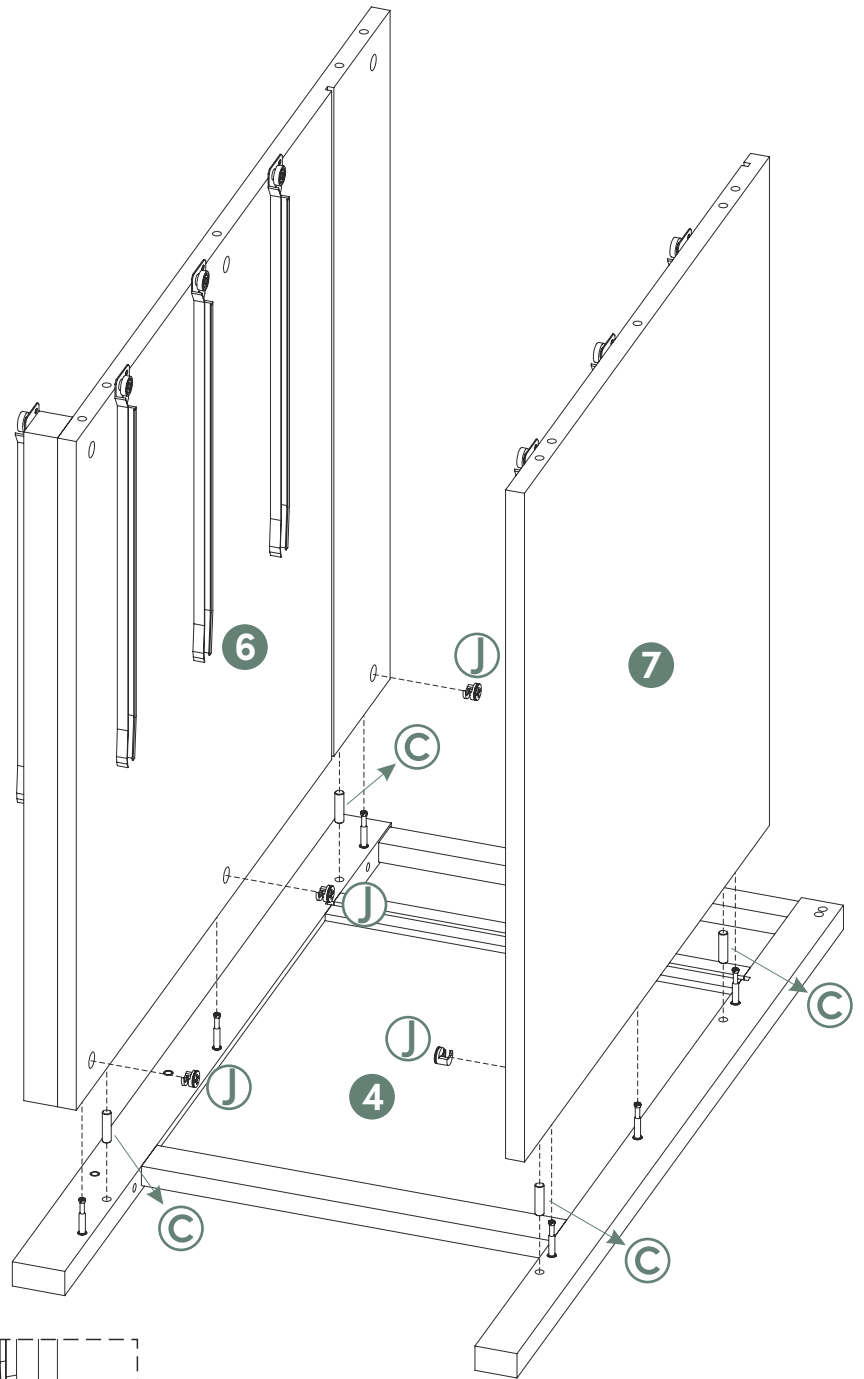
STEP 4

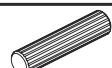

YOU WILL NEED		
C		x4
J		x6

ASSEMBLY STEPS

STEP 5

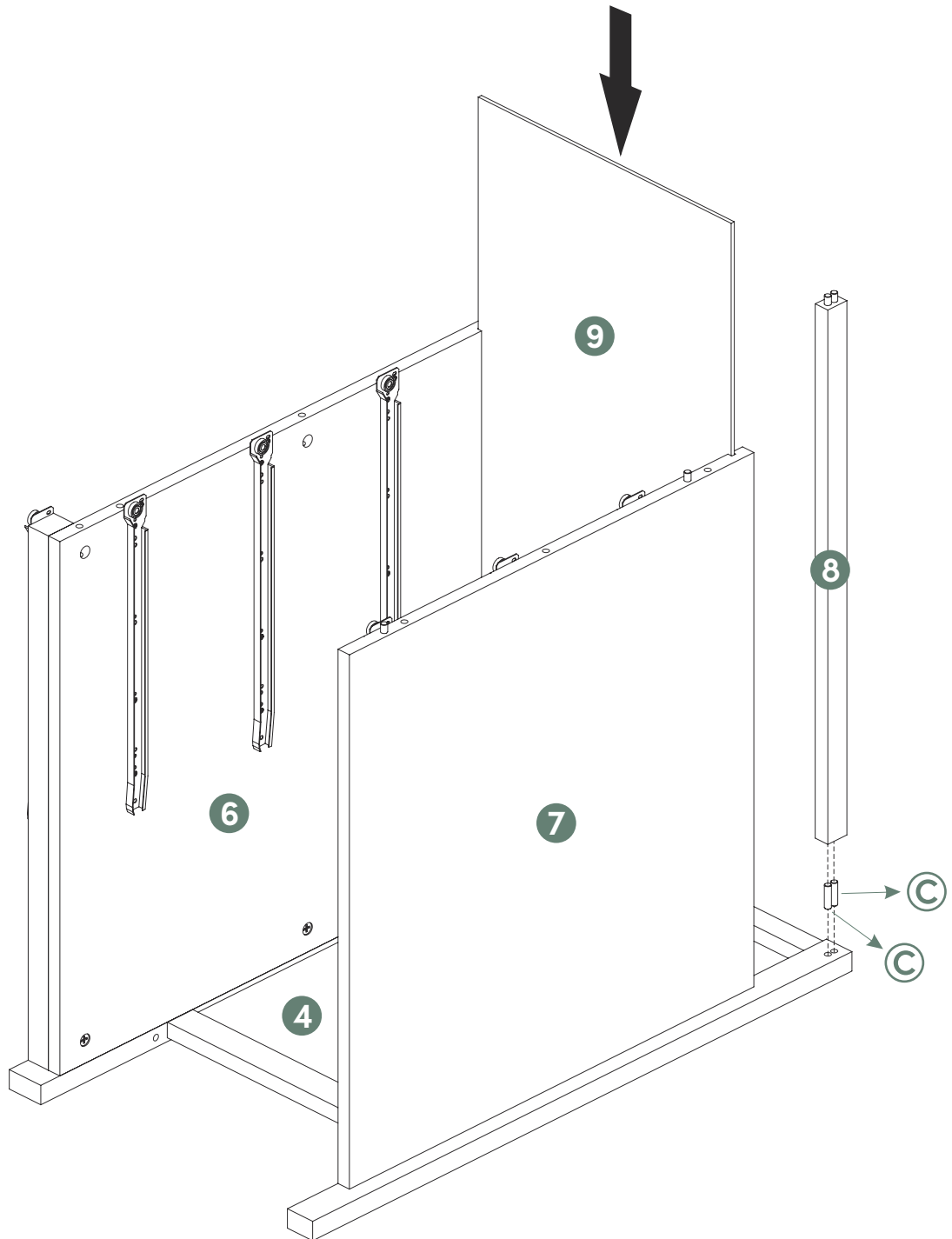

YOU WILL NEED

C

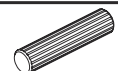



x2

ASSEMBLY STEPS

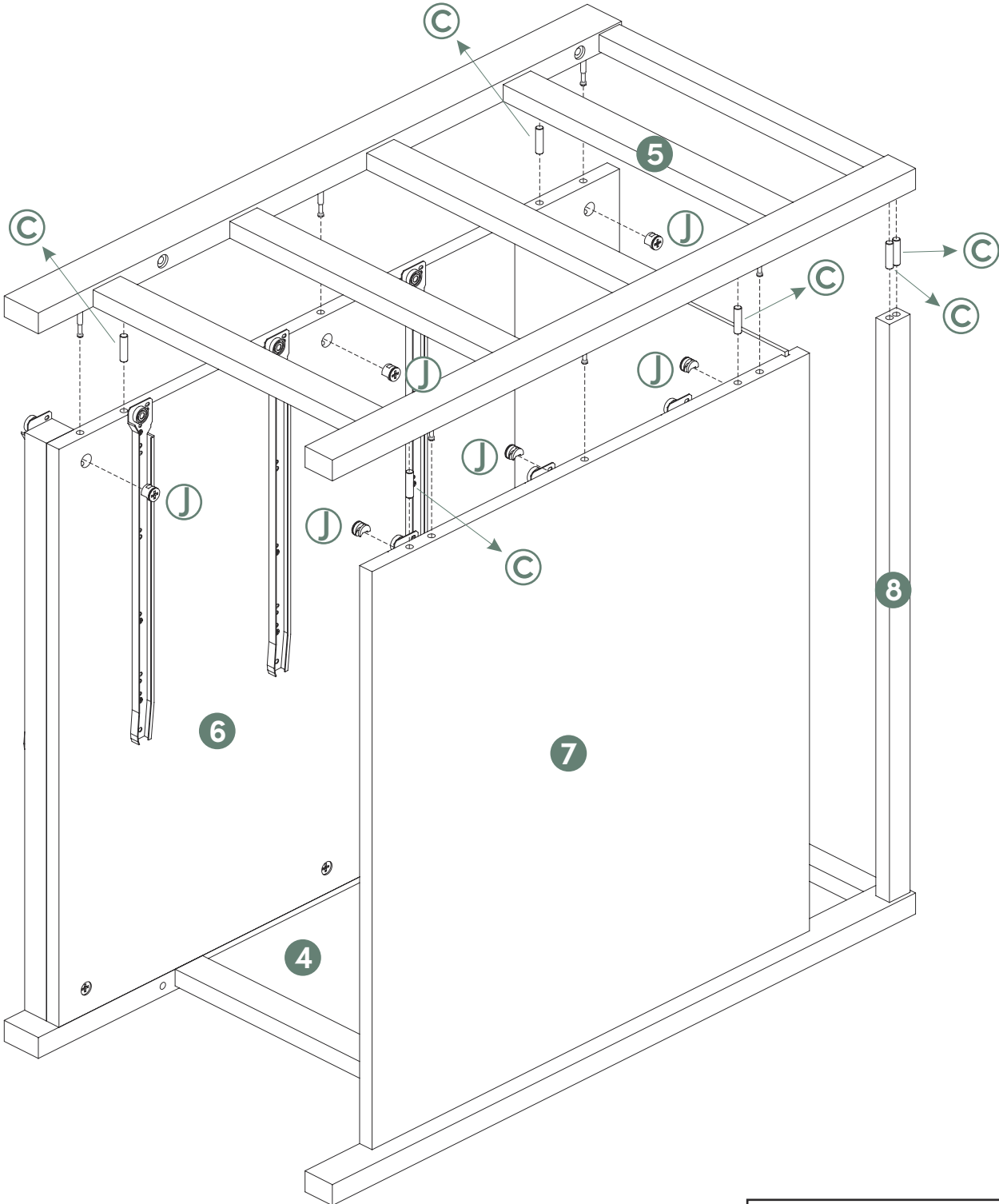
STEP 6

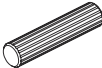

YOU WILL NEED		
C		x6
J		x6

ASSEMBLY STEPS

STEP 7

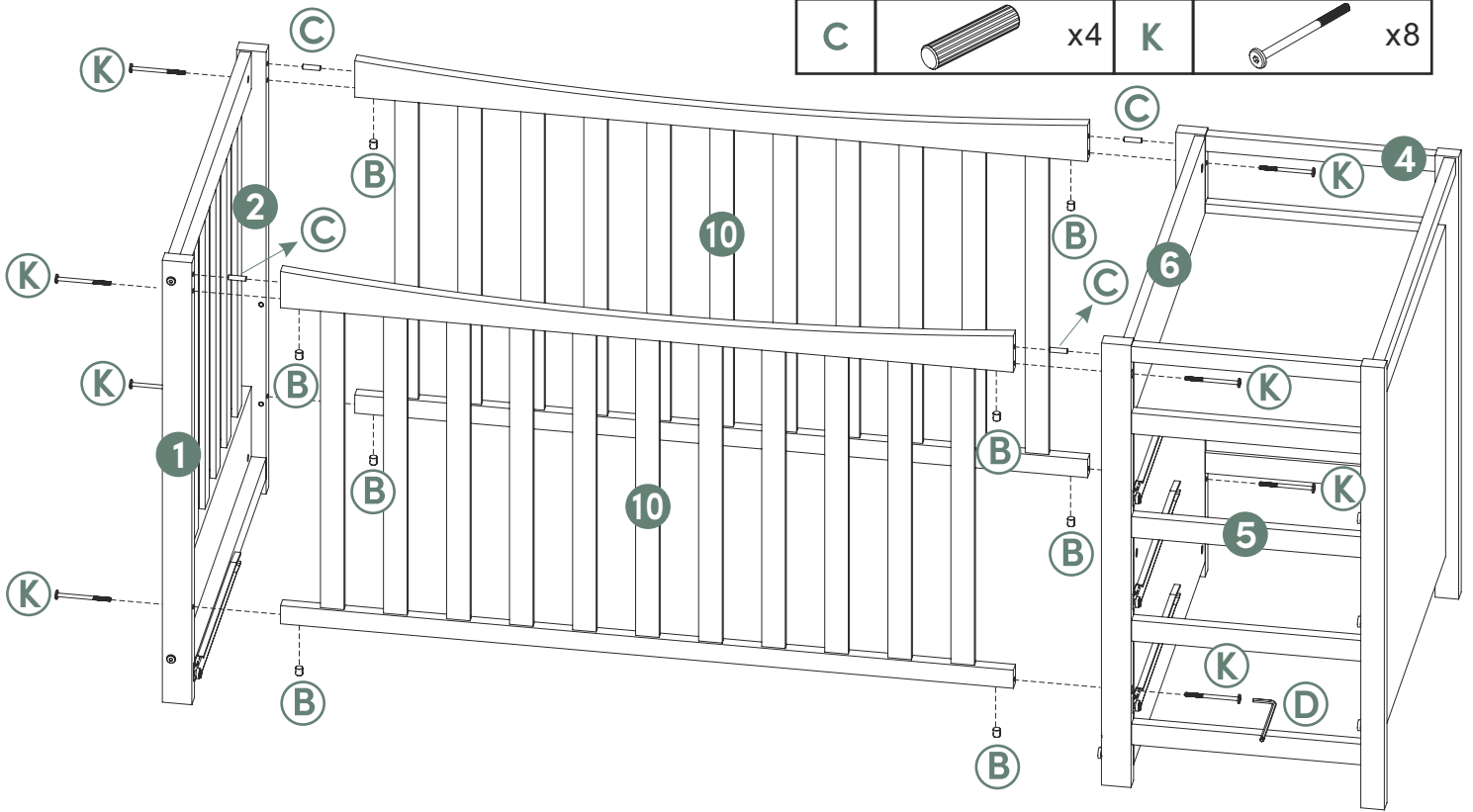

YOU WILL NEED

B		x8	D		x1
C		x4	K		x8



STEP 8

YOU WILL NEED

D		x1
L		x4

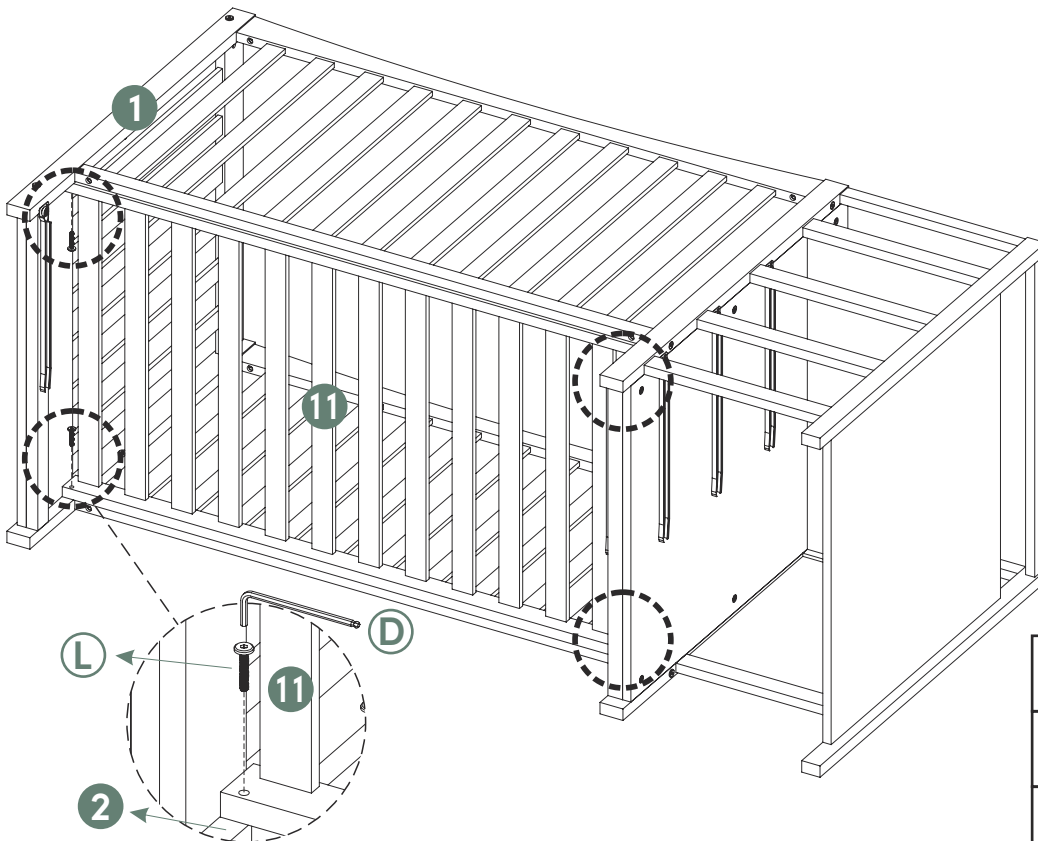

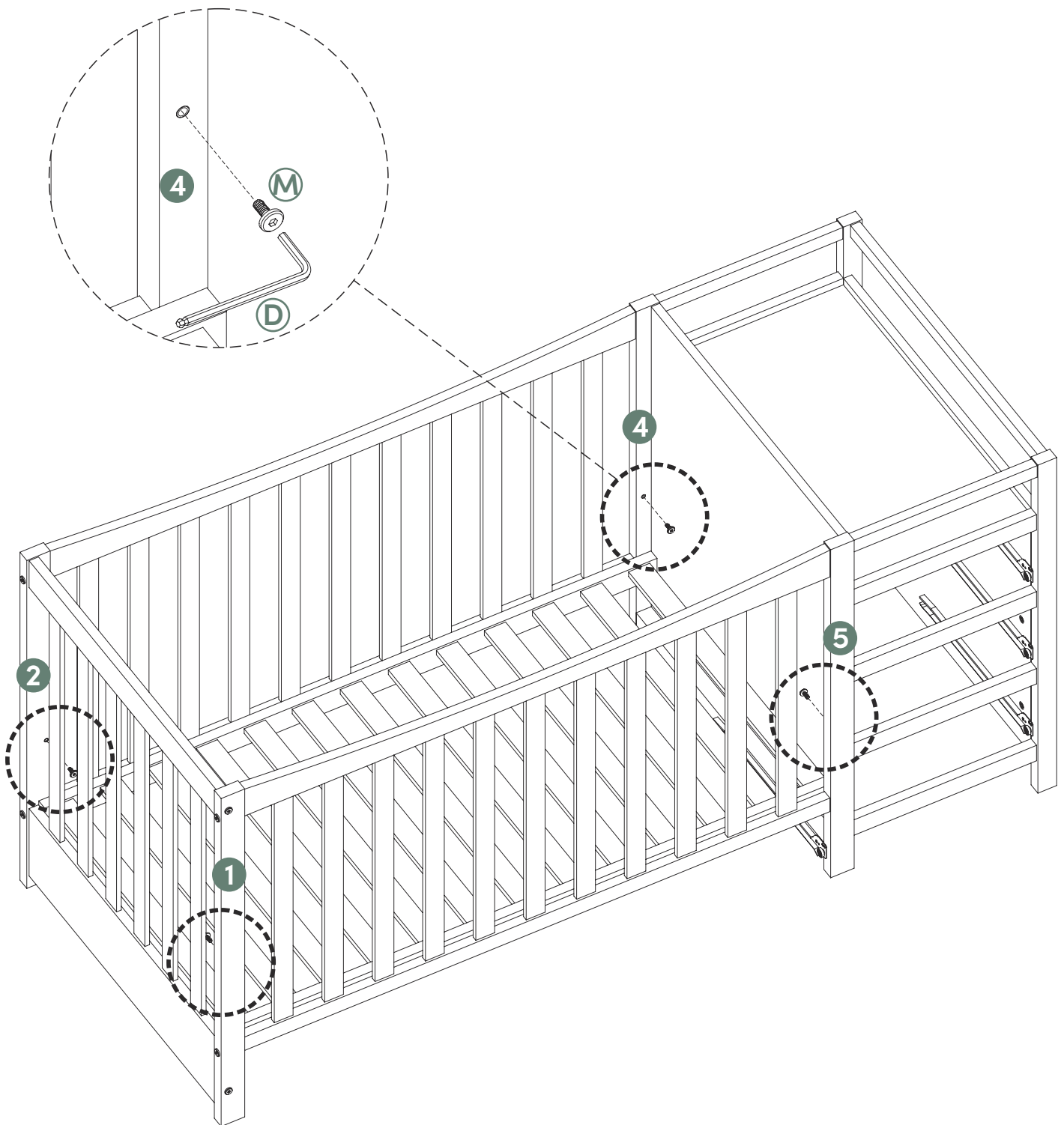

ASSEMBLY STEPS

STEP 9



YOU WILL NEED

D		x1
M		x4

ASSEMBLY STEPS

STEP 10

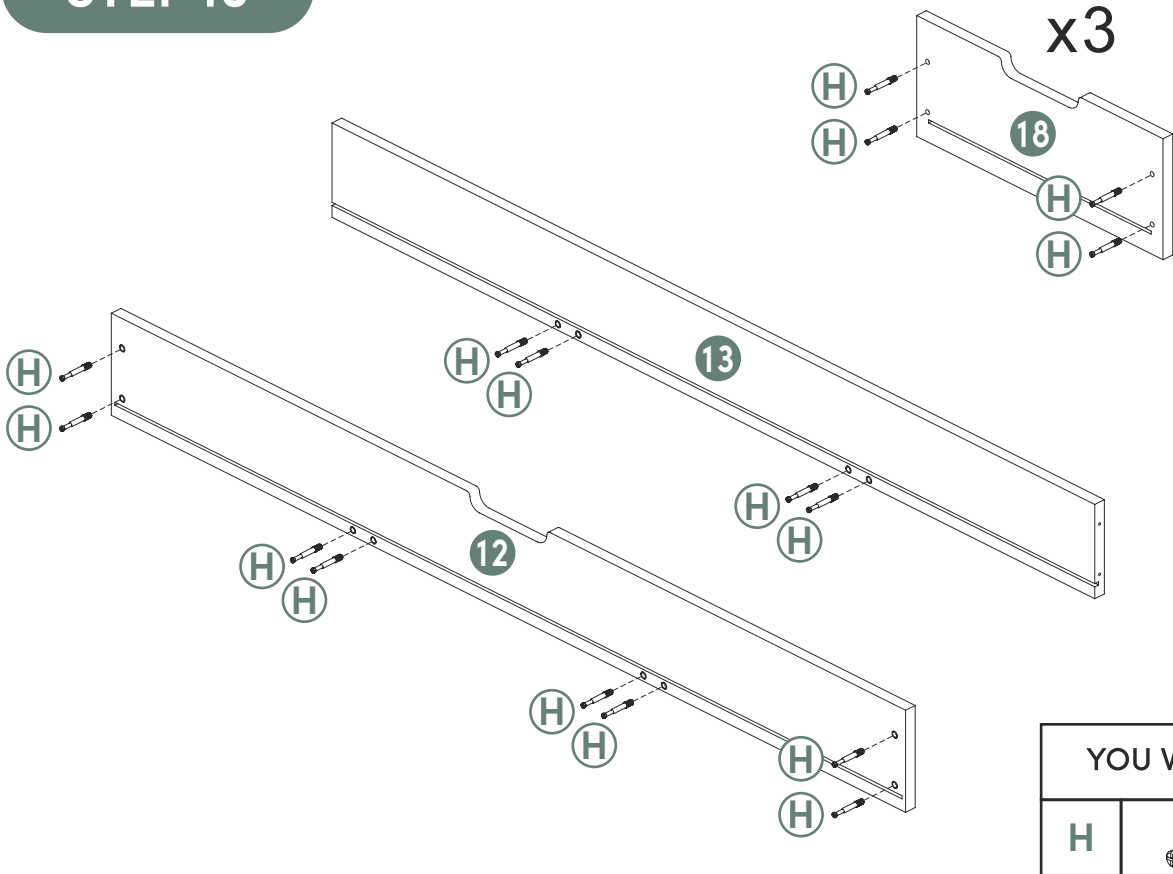

YOU WILL NEED	
H	 x24

STEP 11

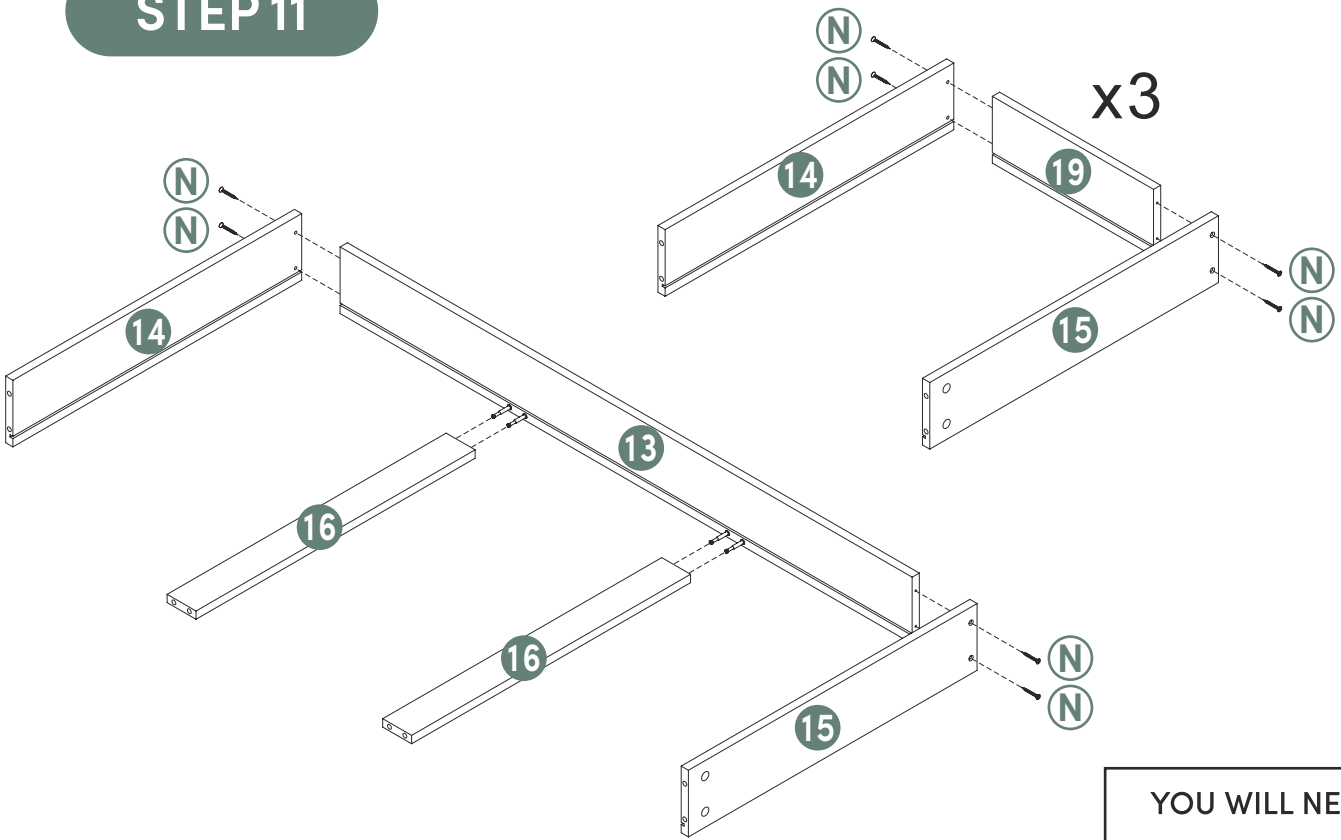

YOU WILL NEED	
N	 x16

ASSEMBLY STEPS

STEP 12

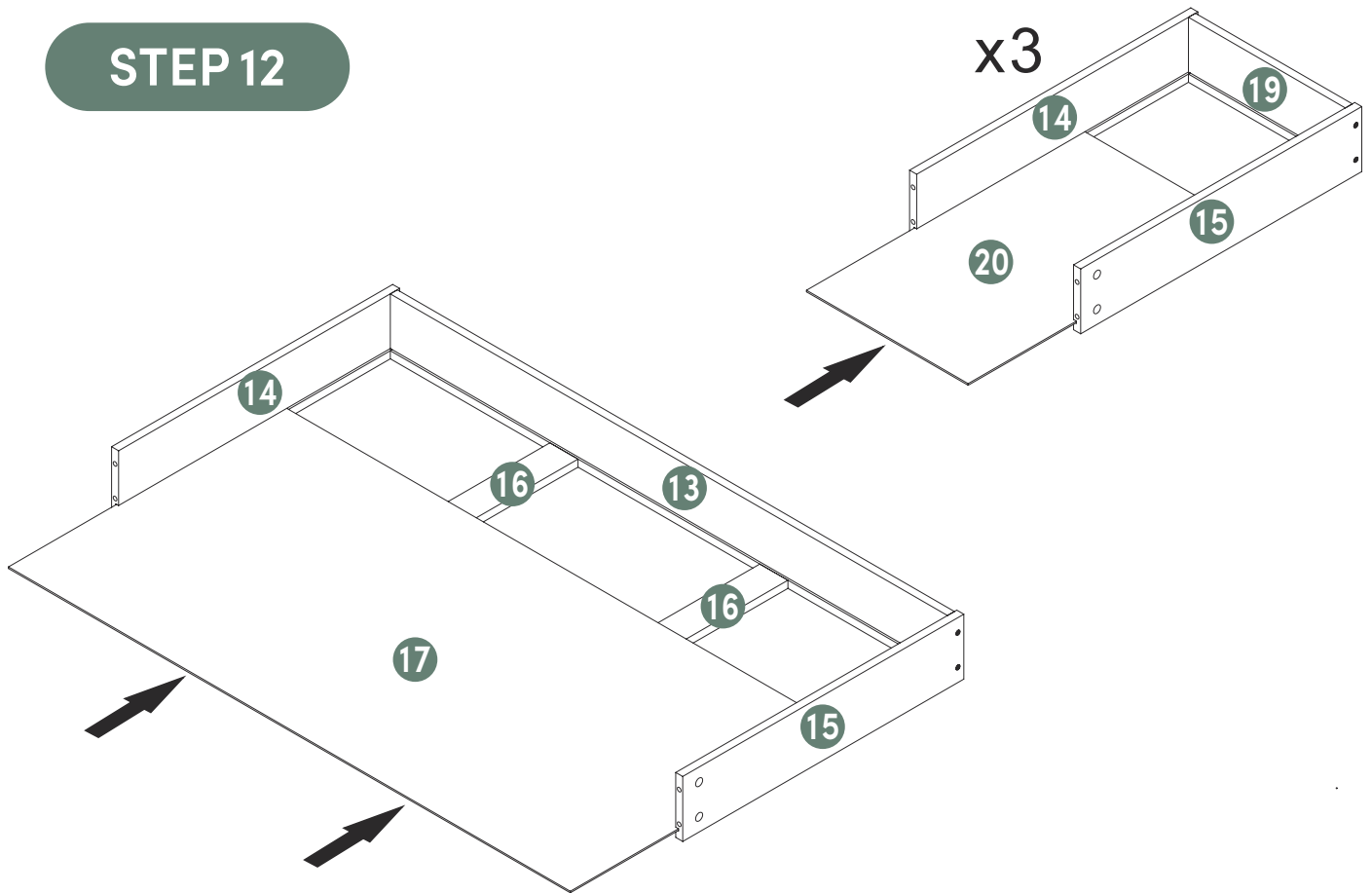

STEP 13

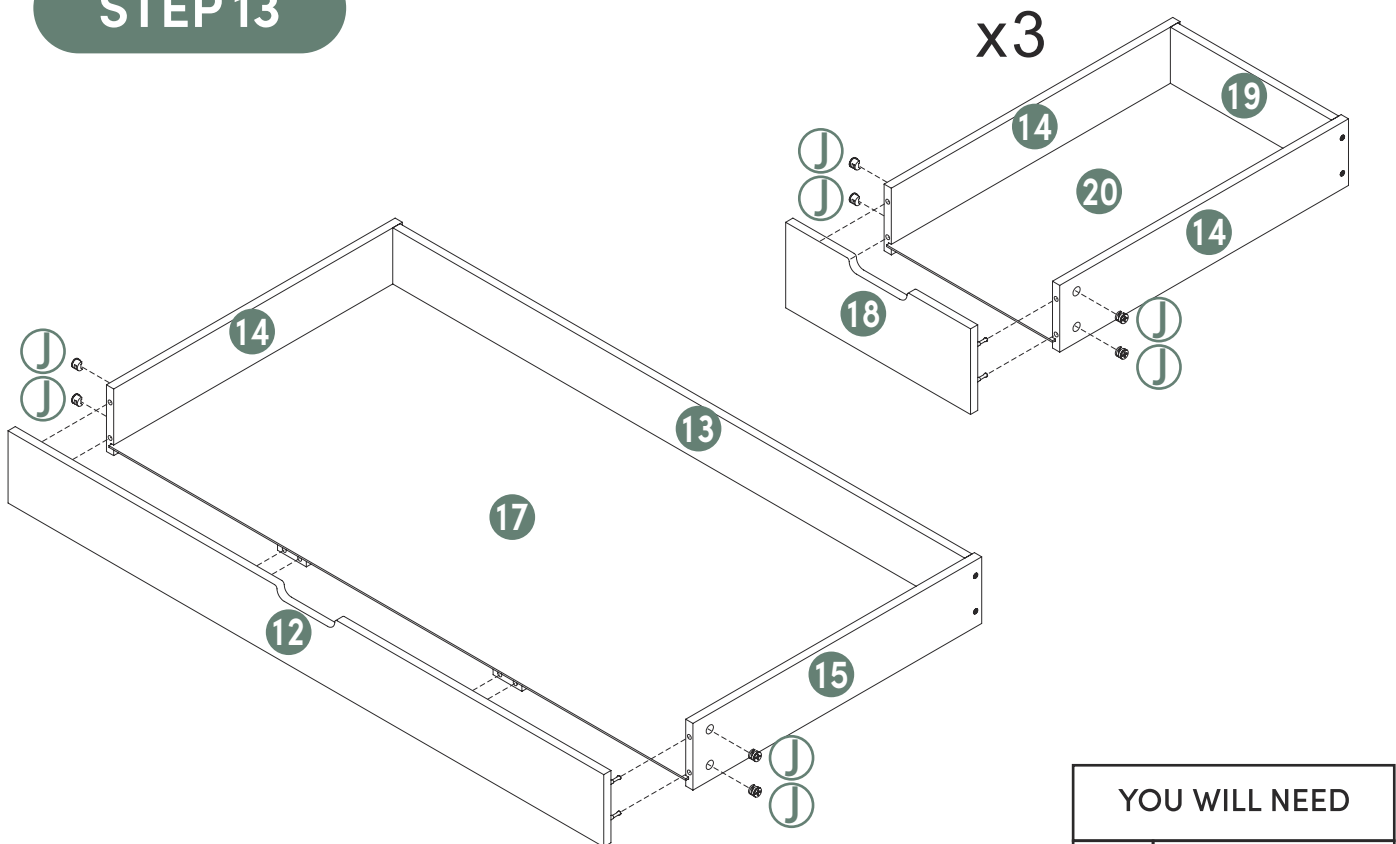

YOU WILL NEED

J





x16

ASSEMBLY STEPS

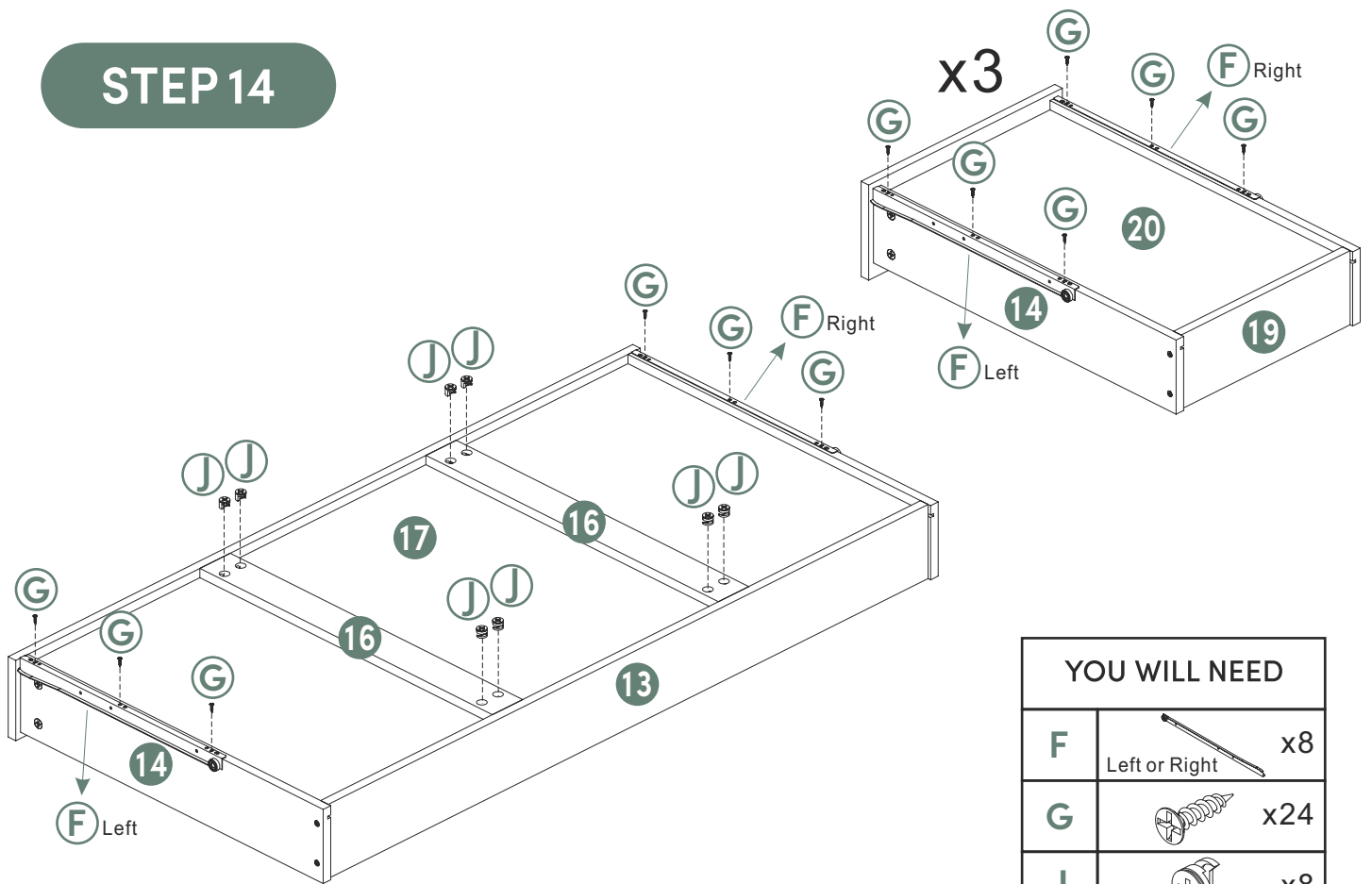
STEP 14



YOU WILL NEED

F	 x8 Left or Right
G	 x24
J	 x8

STEP 15

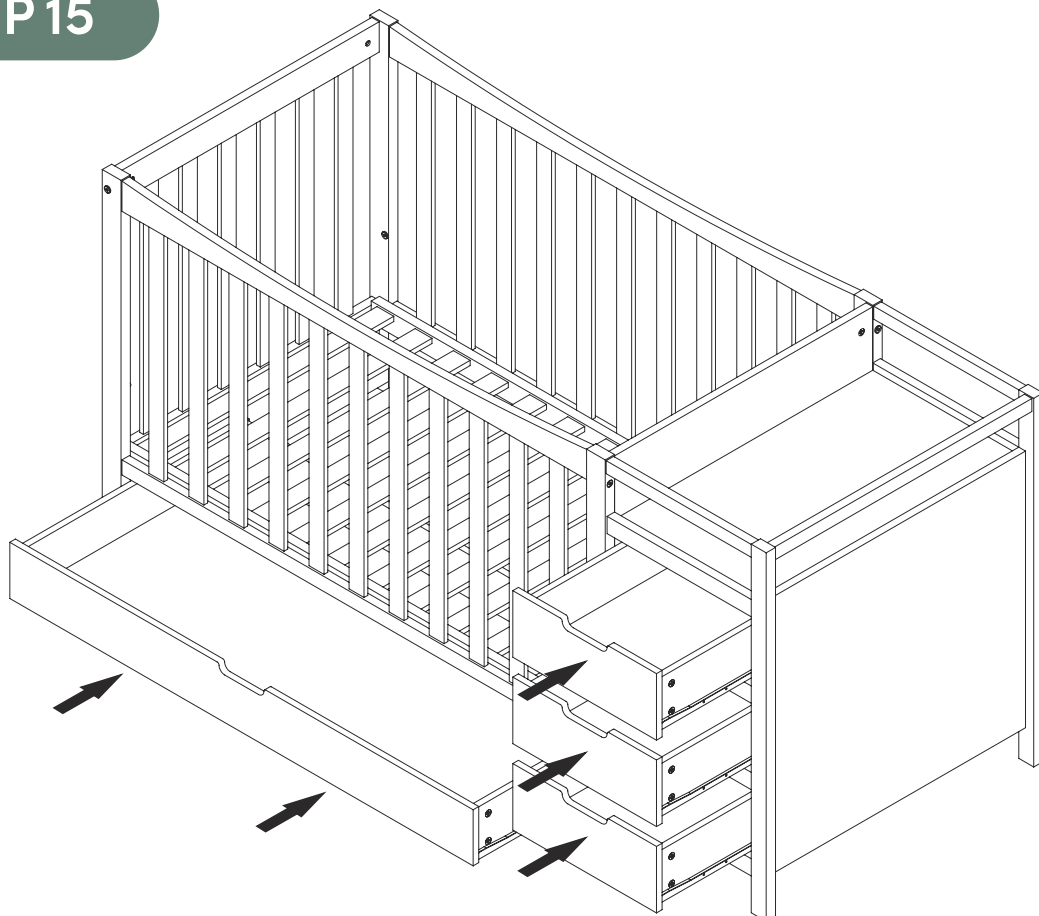

ASSEMBLY STEPS

Adjustable Height – Two settings to match your baby’s development stages.

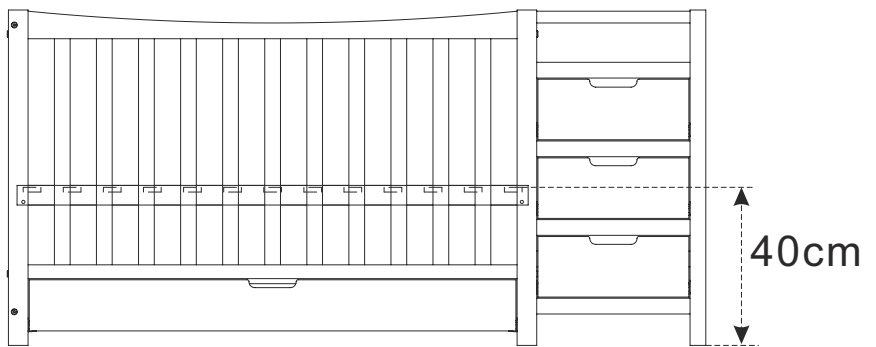
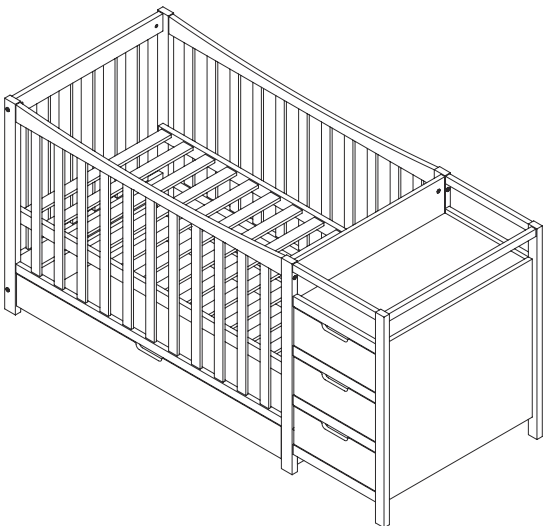
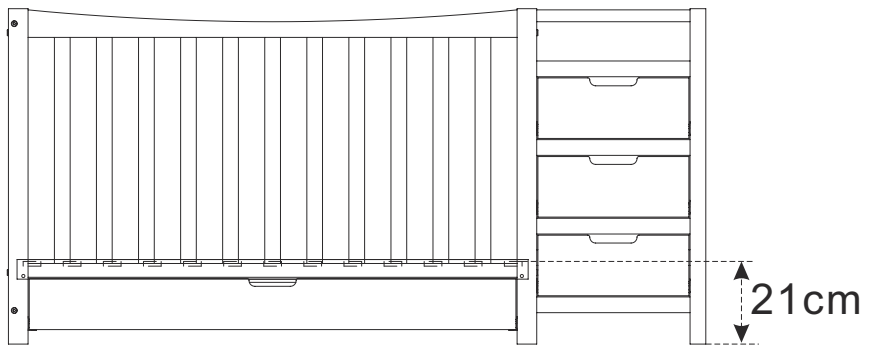
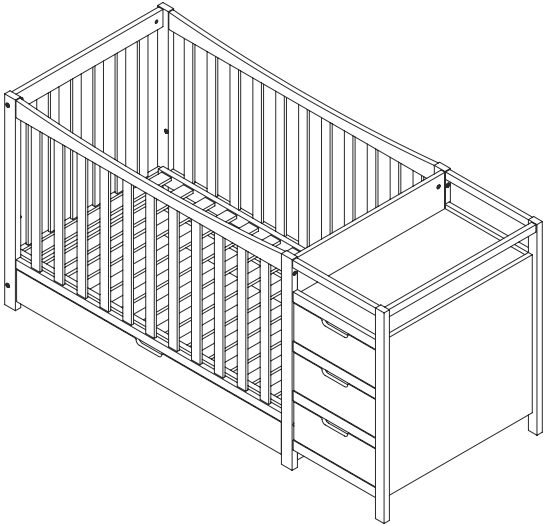

ASSEMBLY STEPS

GREAT JOB. YOU'RE DONE!

To move the assembled unit, please lift it up and do not drag to avoid breaking some parts and damaging the floor.

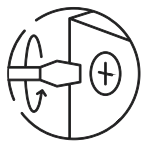

When assembling this baby cot, please ensure that all screws are fastened tightly. After one or two months, please recheck and ensure that all screws are still tight.



Before using this baby cot, please verify the cabinet's structural stability.



Our baby cot can hold weight of up to 60 kg. We don't suggest overloading it beyond its weight capacity.

CARE INSTRUCTION

Follow these basic steps to protect your furniture.

Clean Gently

Use a mild wood cleaner or a mixture of water and mild dish soap to clean spills. Wipe the surface gently with a damp cloth, then dry it thoroughly

Temperature and Humidity

Avoid direct sunlight. Maintain a consistent room temperature and humidity level to prevent wood from warping or cracking.

Use Furniture Pads

Place furniture pads or felt protectors under furniture legs to prevent scratches on floors.

Avoid Excessive Weight

Don't overload the unit beyond its weight capacity.

***Again, we thank you for your purchase.
You've made our day, and we hope you have a great one too!
Enjoy our product!***

For any questions, please call us at 02 8999 1114 or contact our online customer service team through our website.

LUXO|Baby

LUXO|Baby

MAINTENANCE INSTRUCTION

Congratulations on your new piece of furniture. We hope you will enjoy it for many years to come and we suggest that you follow the maintenance advice to ensure a long life for your furniture.

General instructions:

Before using the furniture please wipe with a clean, dry cloth to remove any remaining dust. To preserve the furniture's original appearance avoid rubbing, bumping or scratching the surface with any objects.

Maintenance:

Depending on the amount of use this product received, it may be necessary to tighten the fixings from time to time. This is normal for any flat pack furniture.

Cleaning:

For cleaning, use a cloth (not wet), dry duster and normal furniture polish.

The tools for assembly:

Part L "Allen Key" included in hardware pack.

NOTE:

Follow the guidelines in this user guide to ensure correct assembly and care for this product.

Pls do not use a power tool to assemble this product. Use of power tools may apply greater than necessary force on the fixtures, causing damage. Warranty is void if power tools have been used.

RECOMMENDED MATTRESS SIZE

This cot has been manufactured for use with a mattress which measures 690 mm wide by 1300 mm long and 100mm in thickness. The width and length are specified because it is important that the gaps between the mattress and the sides and ends of the cot will not exceed 40 mm when the mattress is pushed to one side or end, and 20 mm when the mattress is centred in the cot. The thickness of the mattress has been specified to ensure that the depth of the cot is greater than 500 mm with the mattress base in the lower position to minimize the risk of a child climbing or falling out of the cot.

WARNING: TO PREVENT FALLS, THE MAXIMUM MATTRESS THICKNESS SHOULD NOT EXCEED 100MM

WARNING: TO PREVENT FALLS, THE MATTRESS BASE OF THIS COT SHOULD BE ADJUSTED TO THE LOWEST POSITION BEFORE THE CHILD CAN SIT UP

MADE IN CHINA

2023 9 12

Deluxe Products Pty Ltd

160 Newton Road Wetherill Park, NSW 2164

Australia

NOTICE BEFORE ASSEMBLING

We suggest you spend five minutes reading through this short notice before assembling and then follow the instructions step by step.

Point 1: Before assembling , please ensure that you have checked the contents for all relevant parts and counted all metal fittings quantities are correct according with our assembling instruction paper. If you find any accessories quantities are not correct, please kindly stop assembling it at once and take photos back to us.

Point 2: After you have checked all relevant parts and fittings quantities are correct, you would better put all metal fittings and other accessories concentration into one place, such as put into a utensil in case of missing any small fittings in assembling process.

Point 3: To ensure an easier assembly, we strongly advise that all fittings are only finger-tightened during initial assembly phase. Only upon completion of the assembly should all fixing points be fully tightened.

Point 4: We recommend a periodic check on all fixing points to make sure they remain fully tightened.

Point 5: Keep any metal fittings out of children's reach.

Point 6: Do not discard any of the packaging until you have checked that you have all the parts and the pack of fittings.

The need to ensure the cot is placed at a reasonable distance from curtains, blinds, heaters and power points. and the need to keep medication, string, elastic, small toys or small items such as money, out of reach from any position in the cot.