

# User Manual

Lirno 5-Person Full Spectrum  
Infrared Indoor Home Sauna



LUXO|Saunas

welcome.

***Dear Customer,***

Congratulations on your purchase of Lirno 5-Person Full Spectrum Infrared Indoor Home Sauna. We are confident that you will enjoy the many benefits of using the sauna for years to come.

It is essential to carefully and thoroughly read this manual in its entirety before assembling and operating the sauna for the first time. We recommend keeping this manual for regular review and future reference.

Our saunas are crafted from the finest materials, using cutting-edge technology and high-quality workmanship to meet the highest industry standards.

Regular use of the sauna can help improve numerous health benefits, contributing to noticeable improvements in pain relief, weight management, skin health and stress reduction by promoting improved blood circulation.

Discover the unique features of the Lirno sauna, including its numerous health advantages, superior quality, and our team's committed approach to customer service and support.

We are dedicated to ensuring customer satisfaction. Feel free to contact our team if you need any assistance.

**Please call us on 02 8899 1114  
or visit our website [www.luxoliving.com.au](http://www.luxoliving.com.au)  
Once again thank you for choosing our sauna products.**

Best Regards,  
Luxo Living Team

# Table of Contents.

Conditions of Use	01
Packaging and Individual Panel Information	01
Installation Information	03
Assembly Instructions	03
Digital Control Operating Instructions	10
Instructions for Use	13
Tips for Use	14
Safety Instruction	15
Disclaimer	16

## Conditions of Use.

---

1. **Temperature:** +0°C ~ +65°C (+32°F ~ +149°F)
2. **Relative humidity:** ≤85%
3. **Depression:** 700~1060 hpa
4. **Main supply:** AC 220-240V
5. **Frequency:** 50Hz±1
6. **Power:** 4030W
7. **Important:** This product is suitable for use in a standard 20 AMP circuit.
8. **For domestic use only**
9. **Important: Indoor Use Only**

This sauna is designed strictly for **indoor use only** and must be installed **inside a house or building**. It must not be used in outdoor spaces such as garden sheds, alfresco areas, garages, or any other semi-enclosed or open environments. Outdoor use may lead to damage, safety hazards, and void the warranty.

## General Technical Characteristics.

---

1. **Functions processed by microprocessors**
2. **Temperature adjustable from 15°C to 65°C**
3. **Cabin size:** 1800 x 1800 x 2000 mm
4. **Adjustable dwell time from 0 to 90 minutes**
5. **Soft touch key**
6. **Durable carbon fibre heating panels**

## Packaging.

---

Contents of Boxes		
<b>Box 1 of 3</b>  1. Bottom panel 2. Roof panel	<b>Box 2 of 3</b>  1. Front panel 2. Back panel	<b>Box 3 of 3</b>  1. Left panel 2. Right panel



## WARNING!!!

The receptacle provided by the manufacturer must be installed by a qualified electrician only.

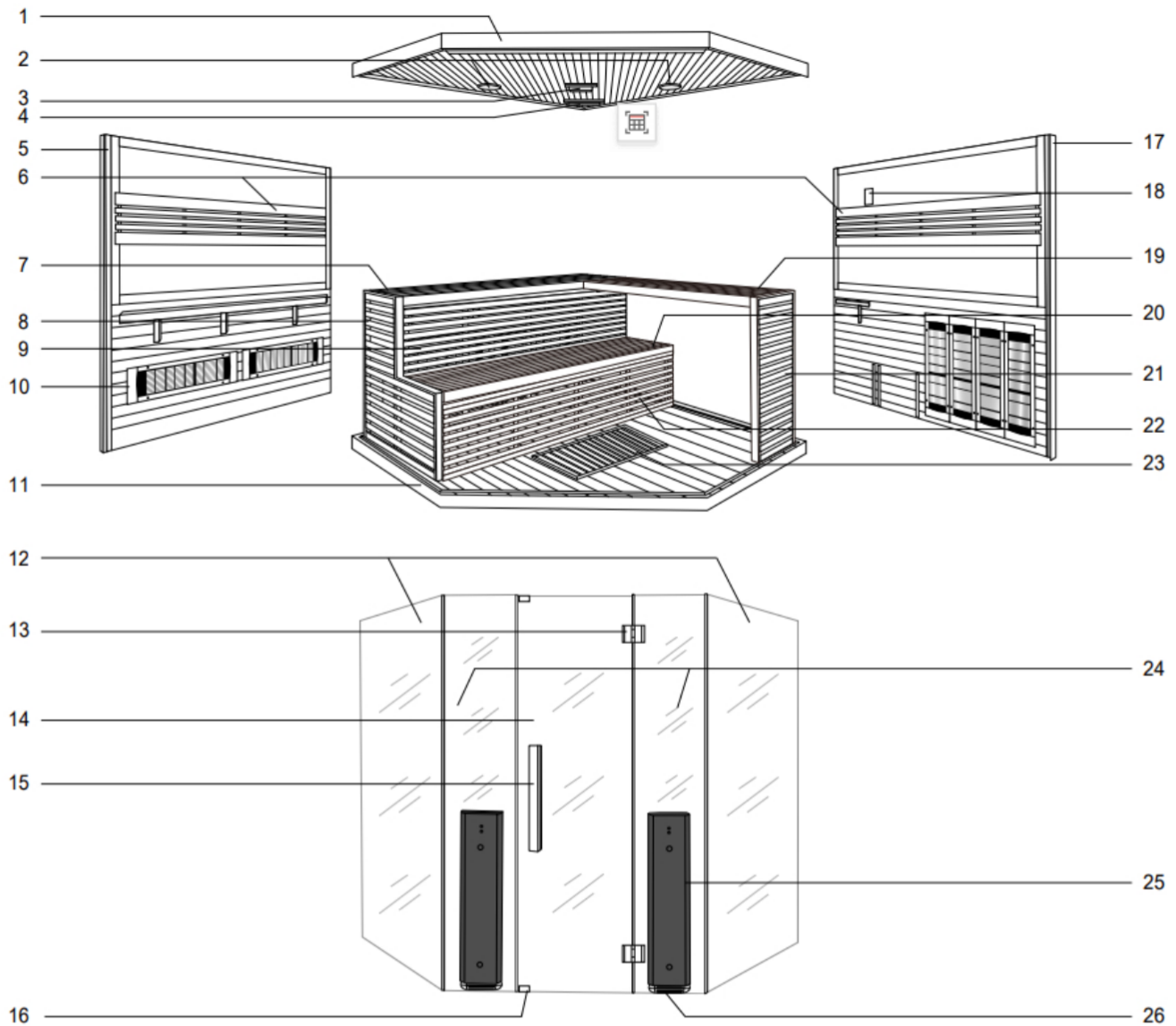

- |                              |                               |
|------------------------------|-------------------------------|
| 1. Roof                      | 14. Front Glass Panel         |
| 2. Speaker                   | 15. Door Handle               |
| 3. Color Therapy Light       | 16. Magnet                    |
| 4. Ventilation Opening       | 17. Right Panel               |
| 5. Left Panel                | 18. Digital Controller        |
| 6. Backrest                  | 19. Upper Right Bench Seat    |
| 7. Upper Left Bench Seat     | 20. Lower Left Bench Seat     |
| 8. L-shaped Bracket          | 21. Right Vertical Panel      |
| 9. Big Left Vertical Panel   | 22. Small Left Vertical Panel |
| 10. Red Light                | 23. Bottom Heater             |
| 11. Bottom Panel             | 24. Glass                     |
| 12. Left & Right Glass Panel | 25. Red Light                 |
| 13. Glass Clip               | 26. Dust Cover                |

## Installation Information.

---

1. Do not plug any other appliances into the outlet with your sauna.
2. The sauna should always be placed on a fairly level surface.
3. This sauna is designed strictly for indoor use only and must be installed inside a house or building. It must not be used in outdoor spaces such as garden sheds, alfresco areas, garages, or any other semi-enclosed or open environments. Outdoor use may lead to damage, safety hazards, and void the warranty.
4. Do not spray the exterior with water. If the floor is consistently damp, you will also need room behind the sauna to allow access to install a floor separator to keep the sauna high and dry.
5. Do not store flammable objects or chemical substances near the sauna.

## Assembly Instructions.

---

Assembly of the sauna requires **at least 2 able-bodied persons** to complete. Please read the instructions thoroughly before and during assembly to ensure proper installation of the unit. If you encounter any problems or have questions during assembly, please feel free to call our Customer Service or local dealers.

### STEP 1. LOCATION OF SAUNA

When determining a location for your sauna, please keep in mind the following:

1. The main power cord of the sauna must be easily accessible.
2. The location must be dry and level.

### STEP 2. PLACING THE BOTTOM PANEL

Place the Bottom Panel on the ground and make sure that the "FRONT" sticker is facing the direction where the front of the sauna would be.

***You will also need room behind the sauna to allow access to install a floor separator to clip in the back panel (Sauna can be slid back after installation).***

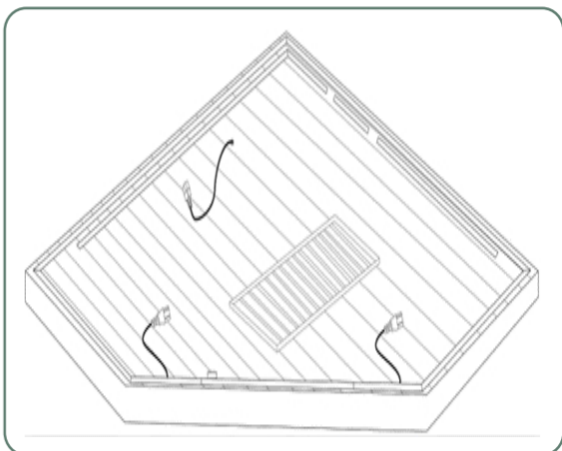

### STEP 3. CONNECTING THE LEFT BACK PANEL TO THE BOTTOM PANEL

Connect the left back panel to the bottom panel by lining up the back panel on the groove of the bottom panel.

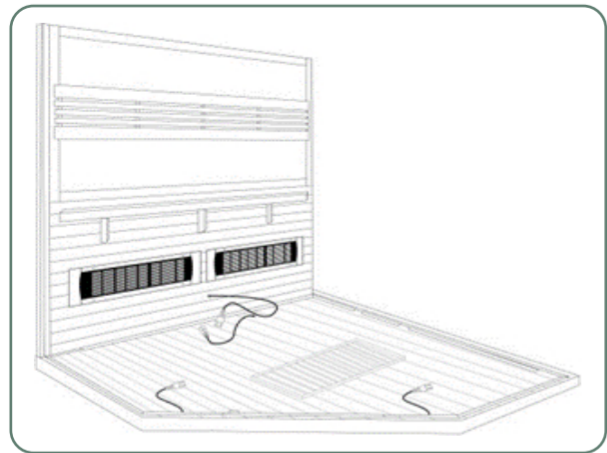
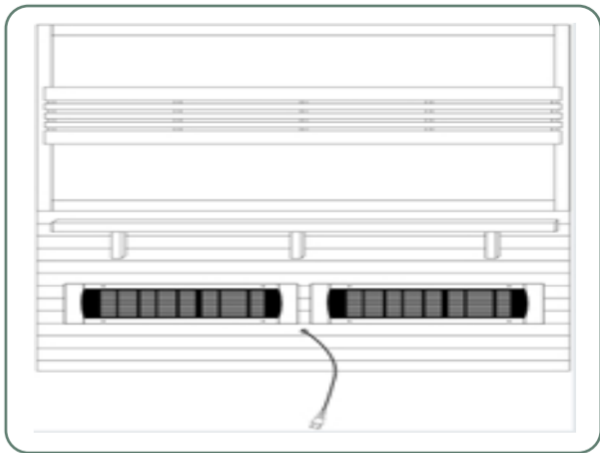

### STEP 4. CONNECTING THE RIGHT BACK PANEL TO THE BOTTOM PANEL

Connect the right back panel to the bottom panel by lining up the back panel on the groove of the bottom panel.

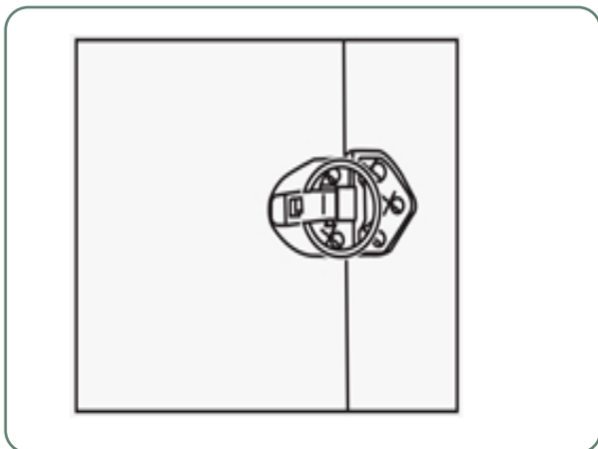
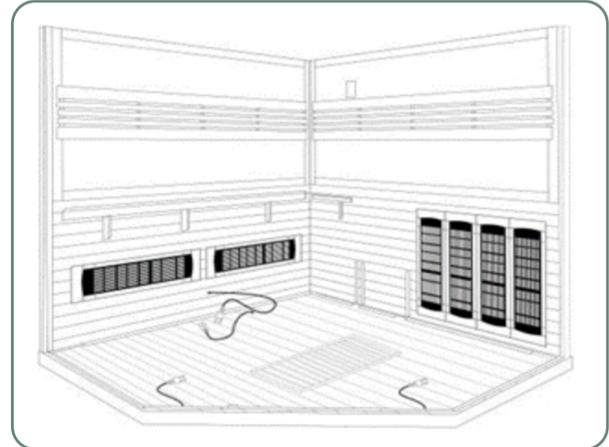
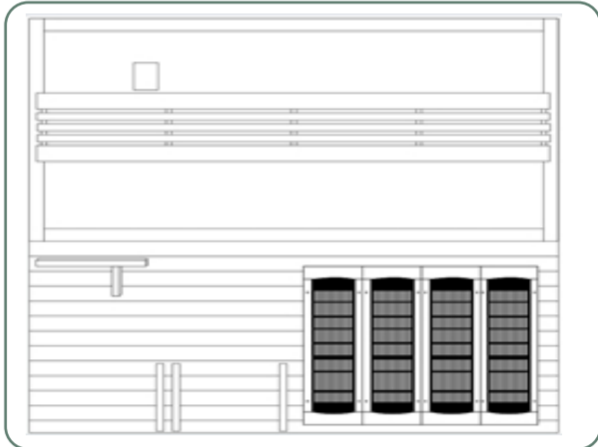

### STEP 5. ASSEMBLING THE ROOF

Secure the slots on the roof panel to the upper part of the back panel and the left and right sides, and then thread out the power cable inside. After that, insert the corresponding connectors together.

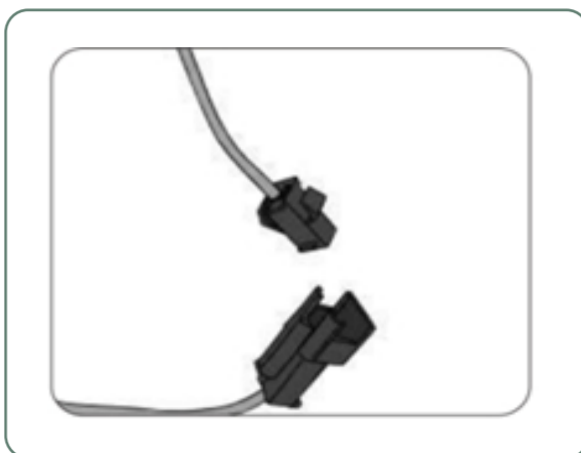
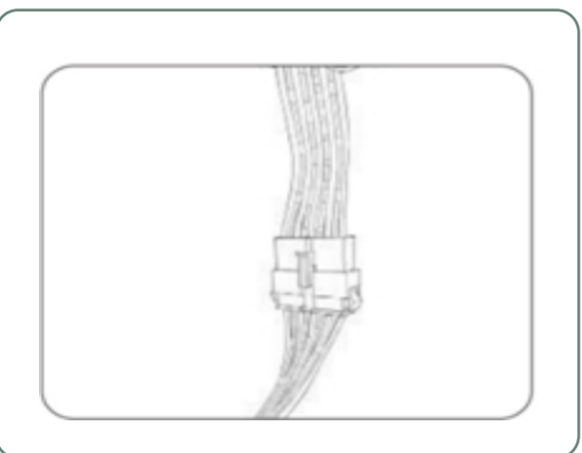
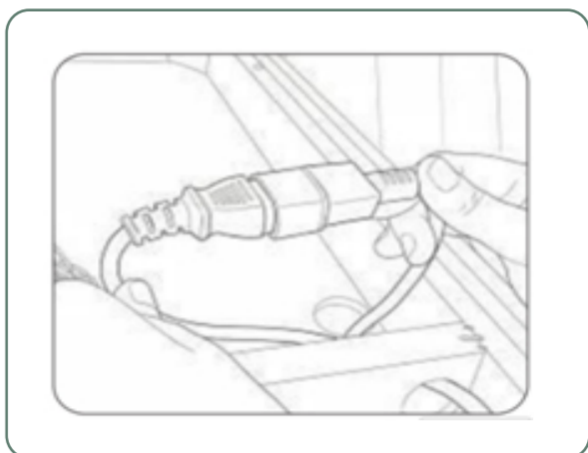
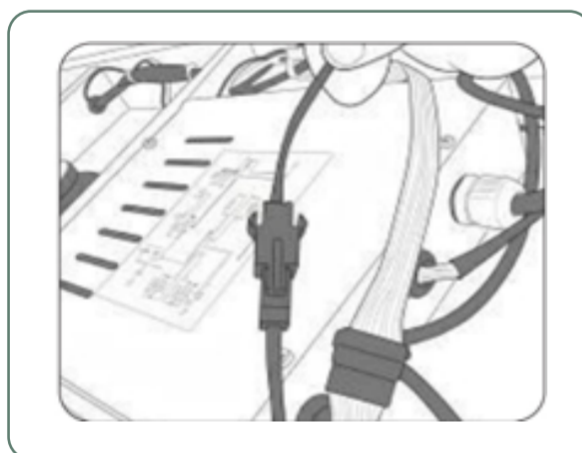
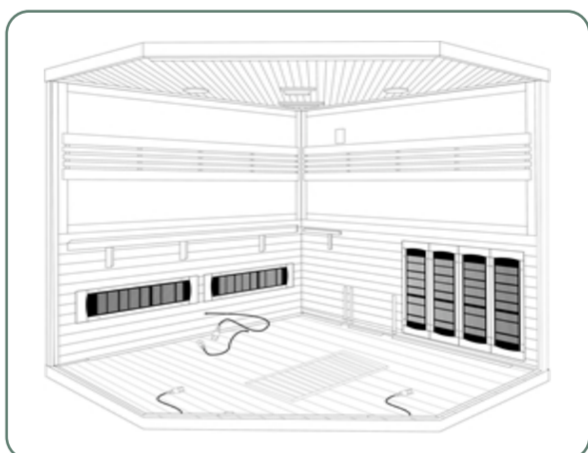
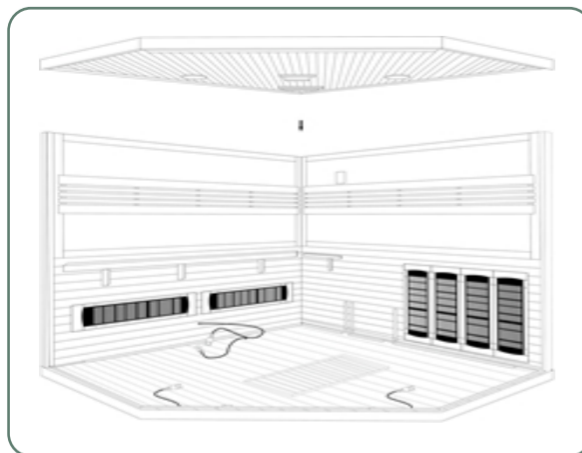
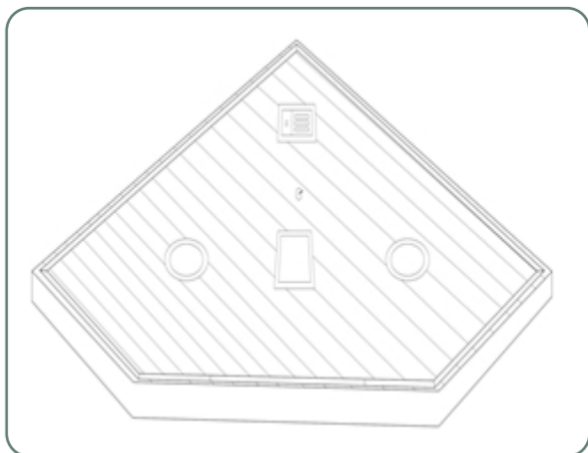

## STEP 6. CONNECTING THE LEFT AND RIGHT GLASS PANEL

Place the glass on the left side on the bottom panel, and insert it into the slots at the roof, bottom and left back panel.

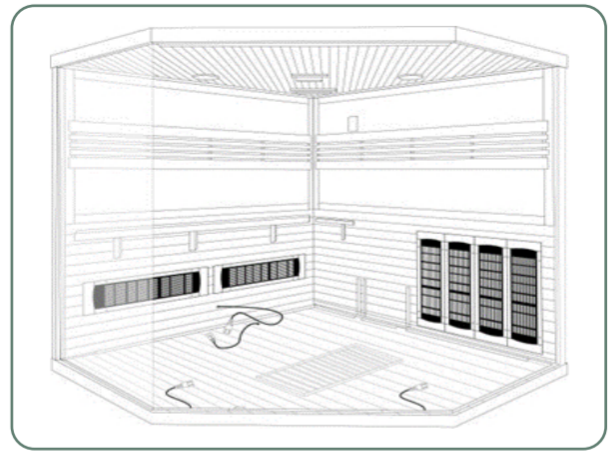
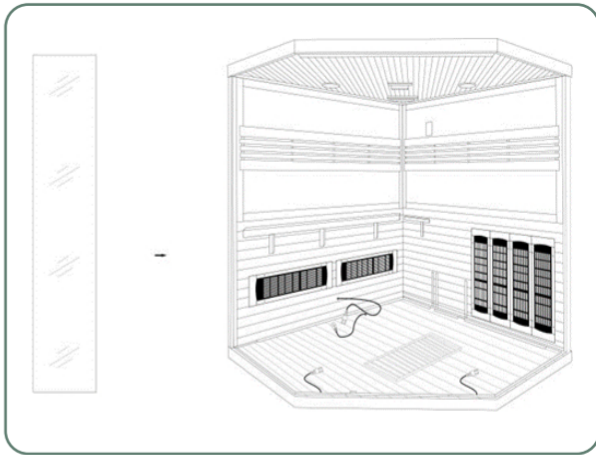

Place the glass on the right side on the bottom panel, insert the glass into the grooves at the roof, bottom and right back panel, and install the sealing strips on both sides of the glass.

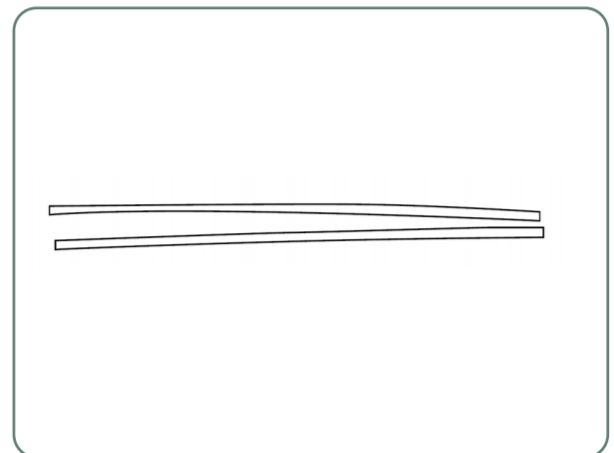
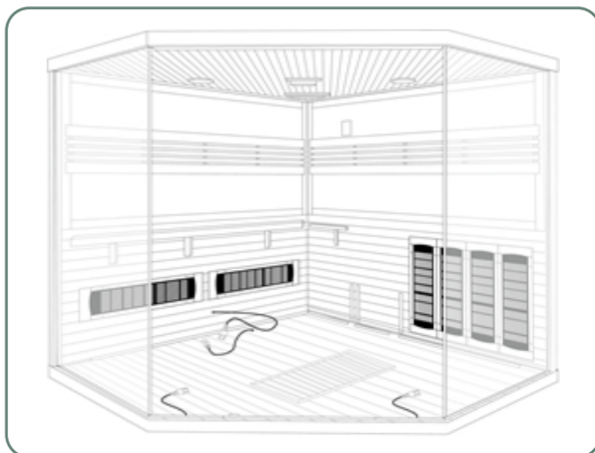
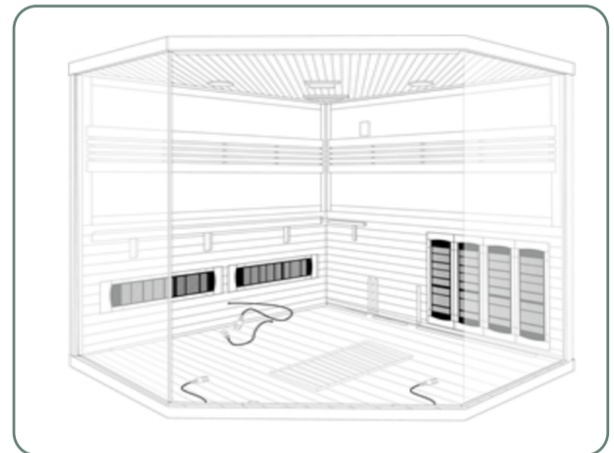
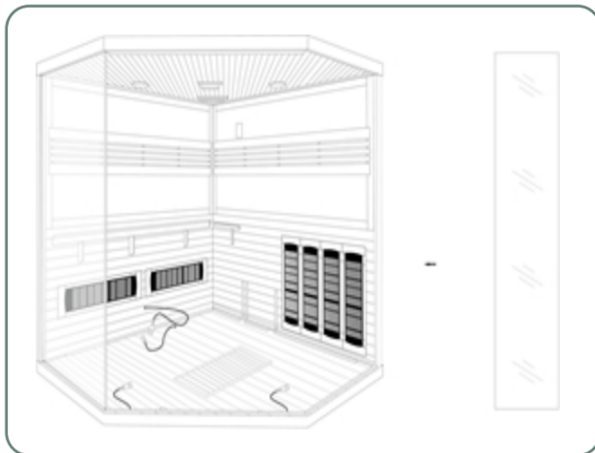

### STEP 7. INSTALLING THE SIDE GLASS

Place the glass on both sides of the front panel into the slots on the roof and bottom panels, and connect it with the glass on the left and right sides with sealing strips.

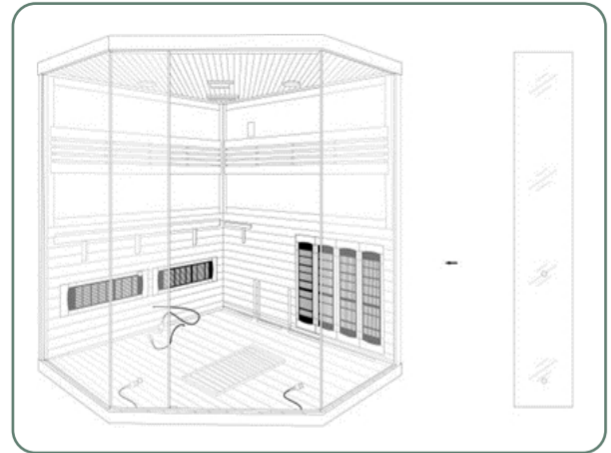
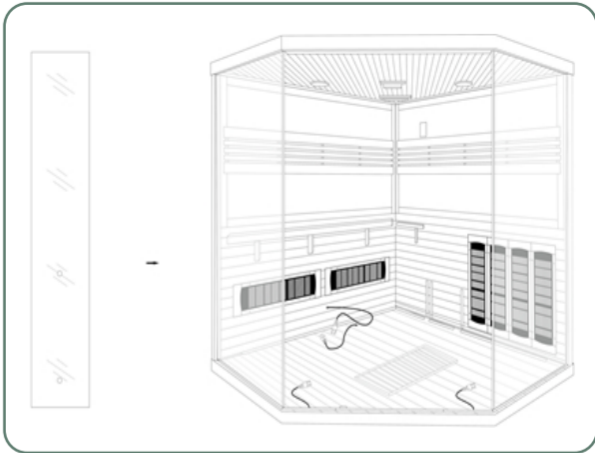

### STEP 8. INSTALLING THE GLASS DOOR

Place the glass door on the front panel, fix it with the door hinge, and then install the glass sealing strip.

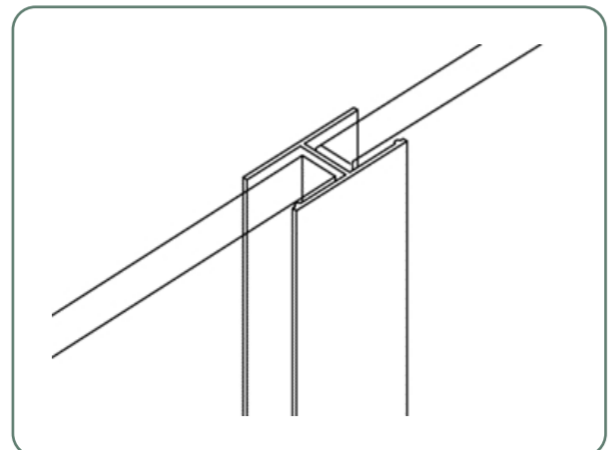
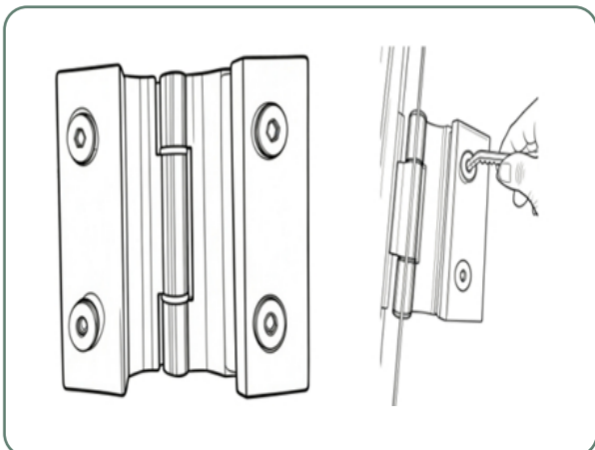
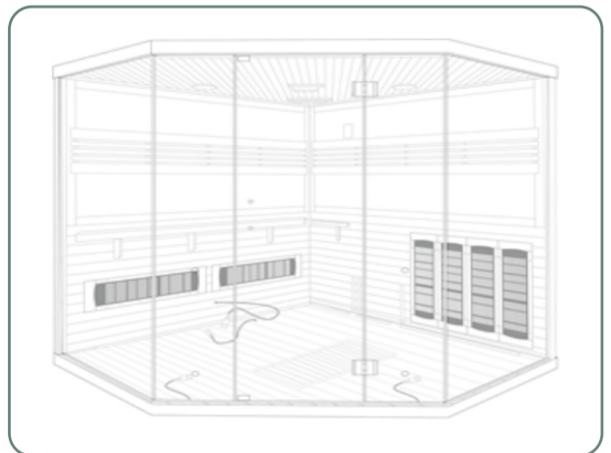
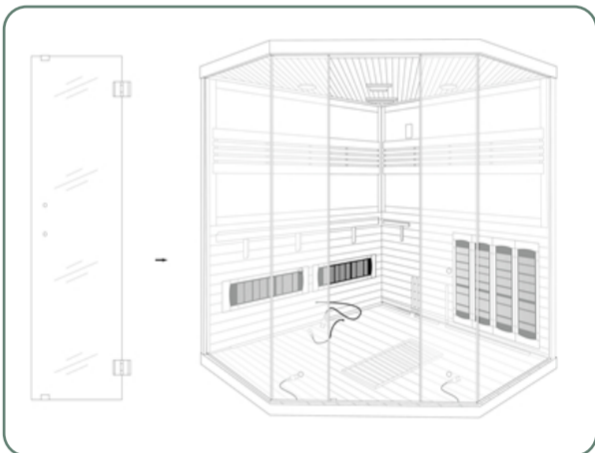

Place the magnetic strips on the door glass and side glass, and check whether the magnetic attraction effect fits well.

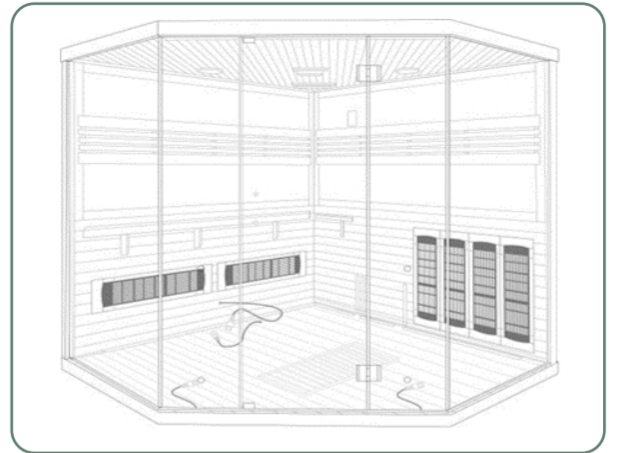
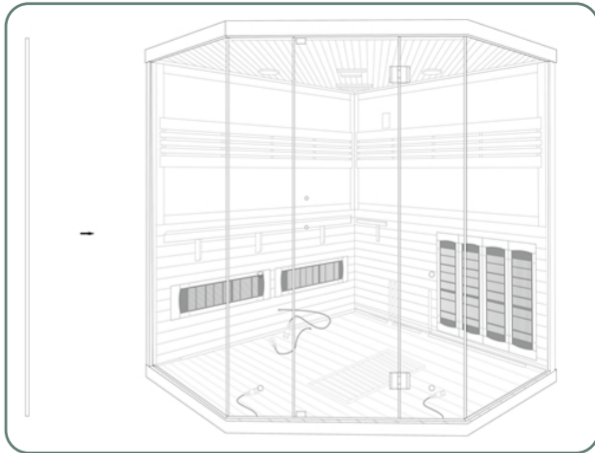

Connect the power cable on the back panel to that on the bottom panel.

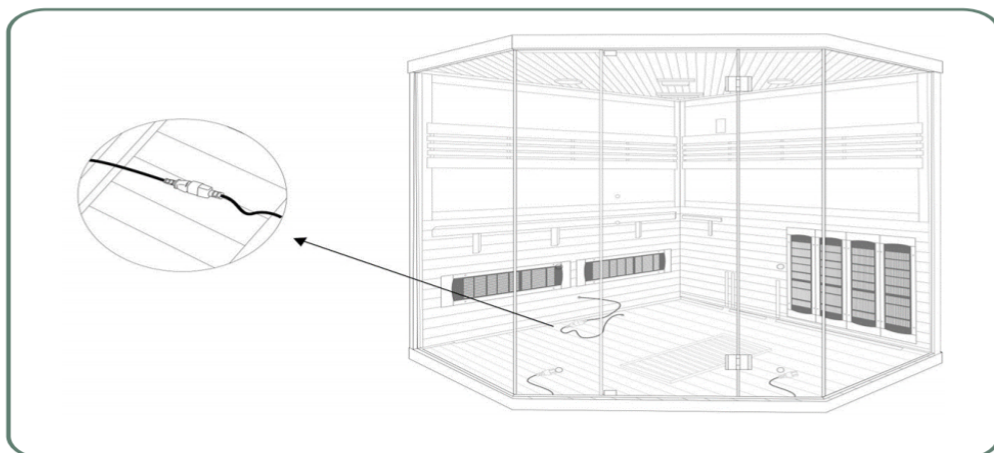

## STEP 9. ASSEMBLING THE BENCH

Place the L-shaped vertical plate on the left side of the glass.

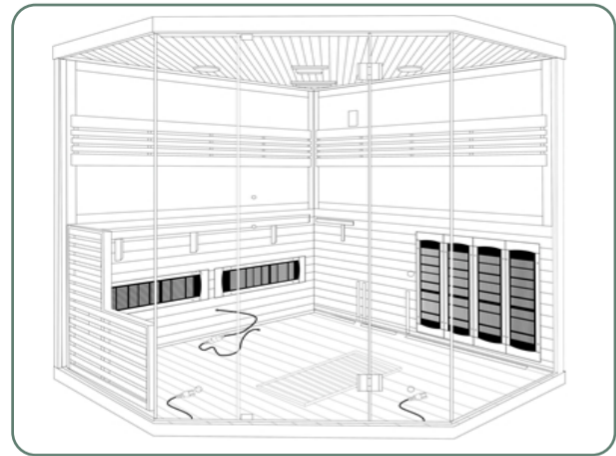
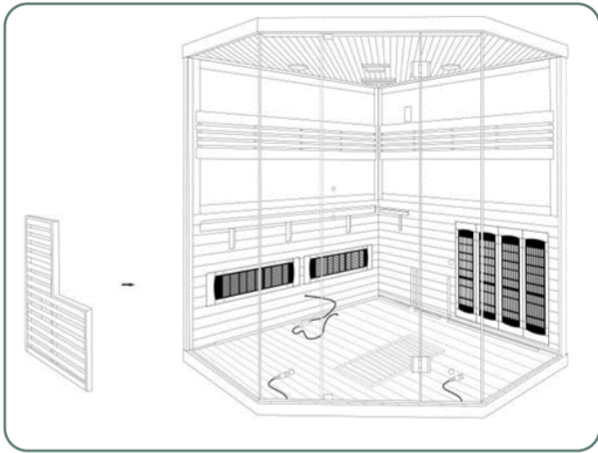

Place the left back big vertical panel in the slot between the L-shaped vertical plate and the right back panel.

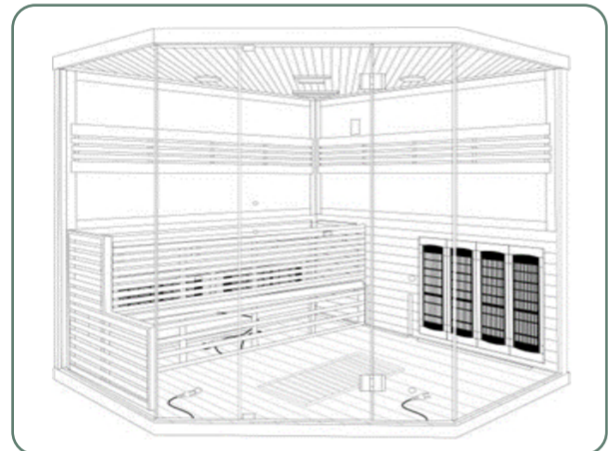
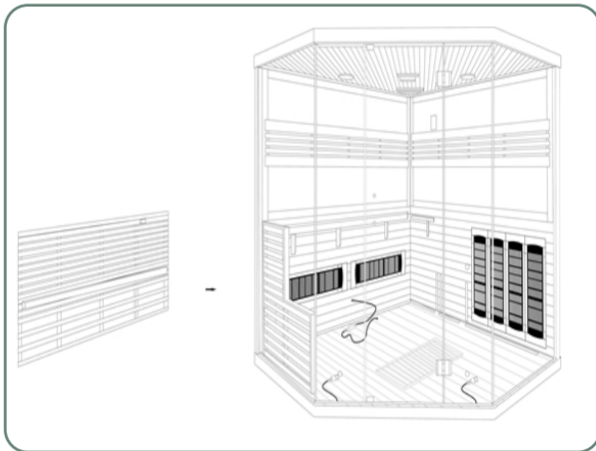

Place the bench seat of the left back panel above the big vertical panel, align the edge and adjust it to ensure it is smooth and stable.

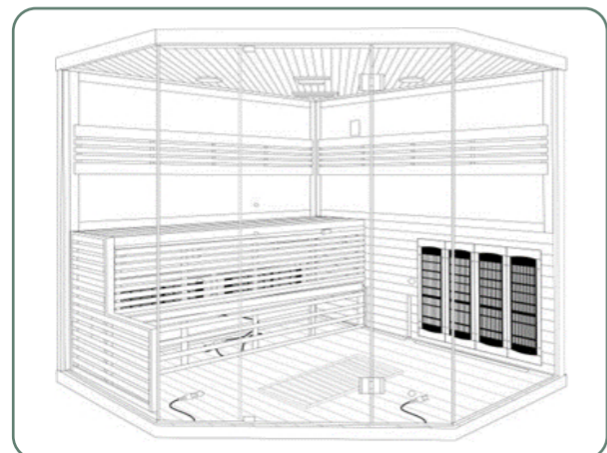
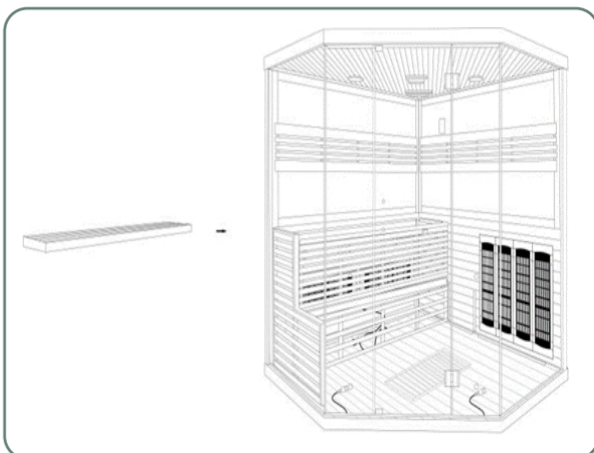

Place the small vertical panel of the left back panel in the slot between the L-shaped vertical panel and the right back panel, and then make sure the entire structure is stable.

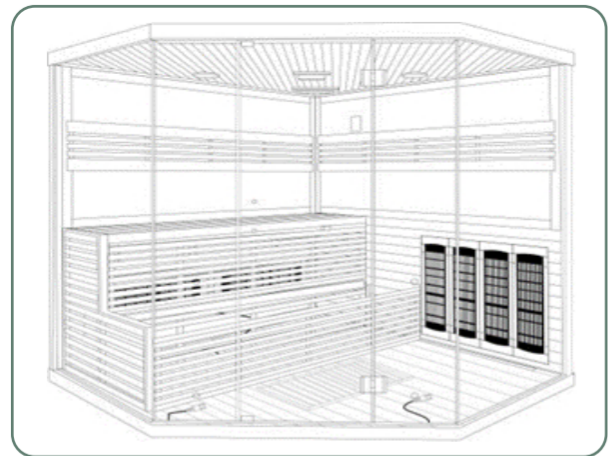
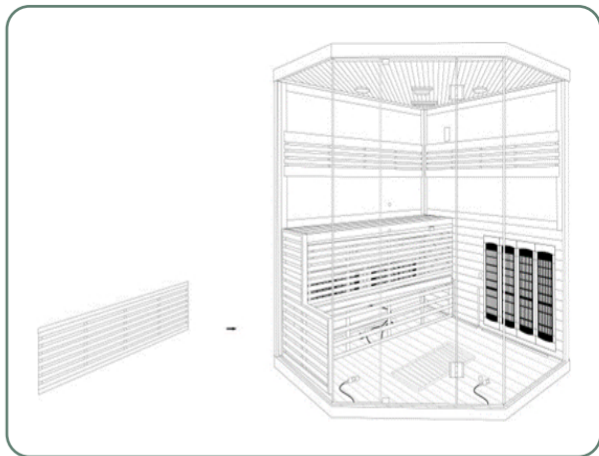

Place the lower bench seat of the left back panel on the vertical panel and ensure it is stable and free from shaking.

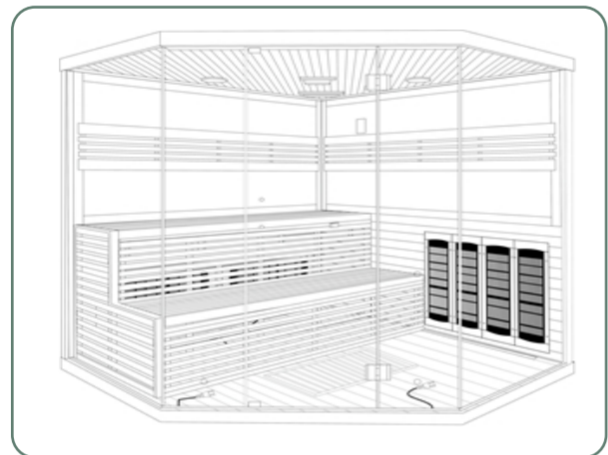
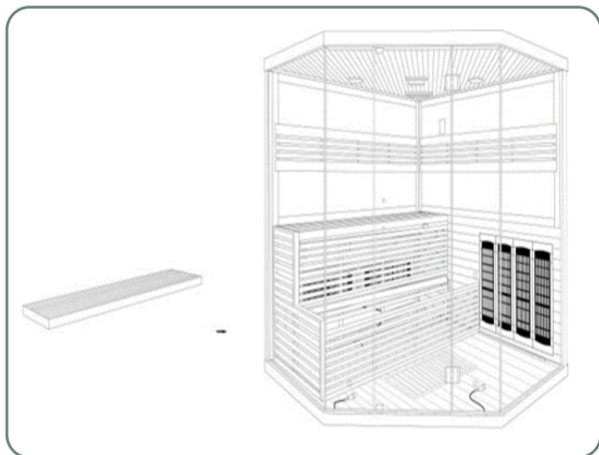

Place the vertical plate of the right rear panel at the position of the right glass and level it.

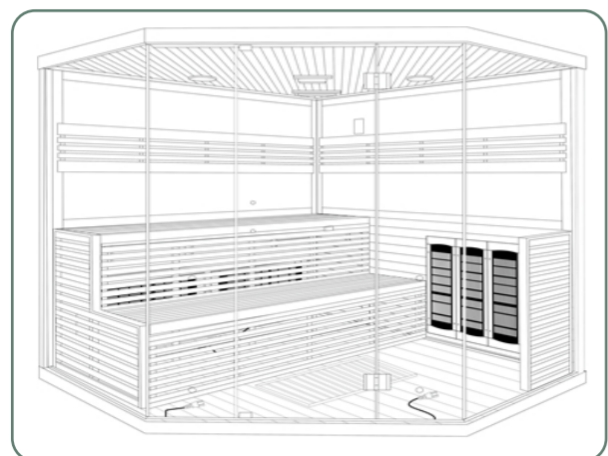
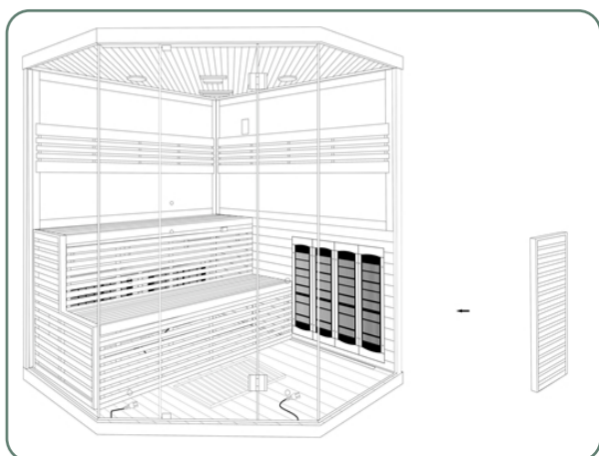

Place the bench seat of the right back panel on the support between the vertical panel and the back panel and ensure that the bench seat is stable and free from shaking

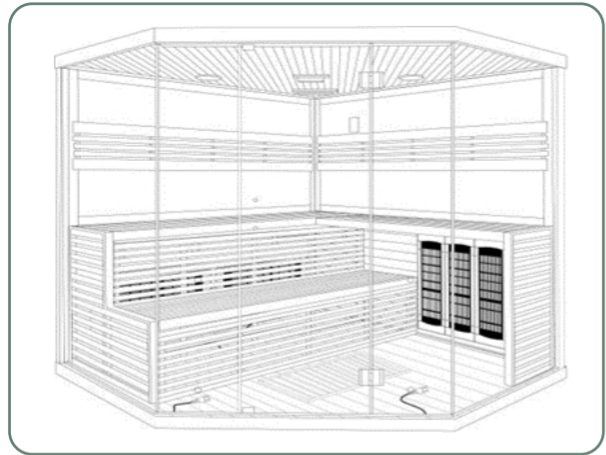
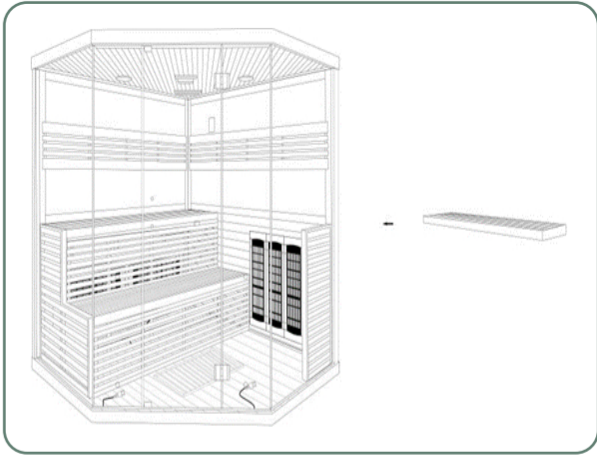

**STEP 10. INSTALLING THE RED LIGHT**

Install the black reflector on both sides of the door glass, fix it with mirror nails, and connect the power cable together. (12pcs\*20mm screws needed)

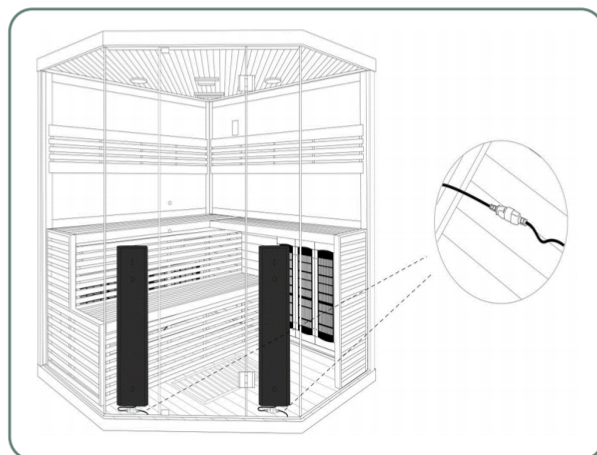
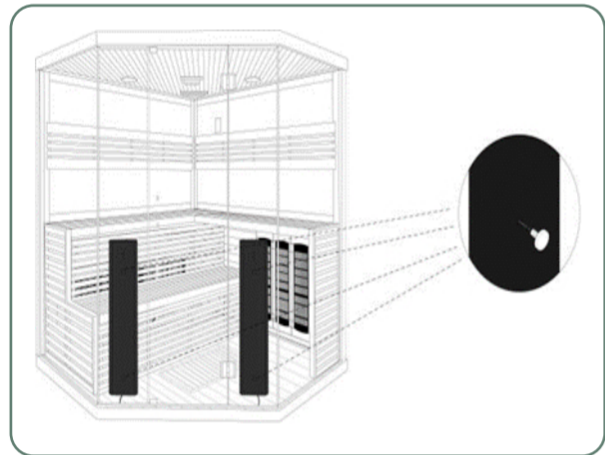
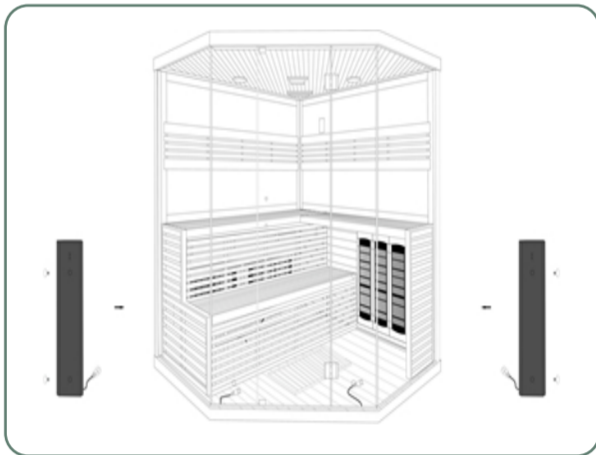

**STEP 11. INSTALLING THE DOOR HANDLE**

(4pcs\*80mm screws needed)

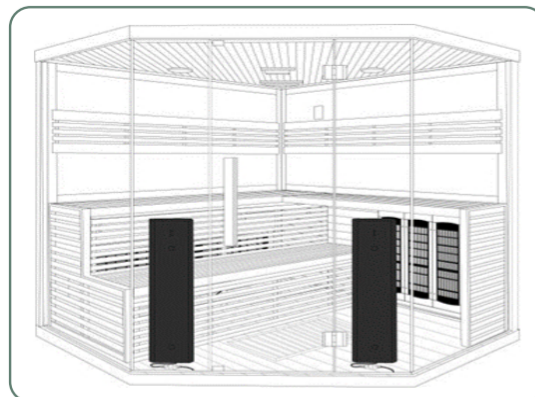
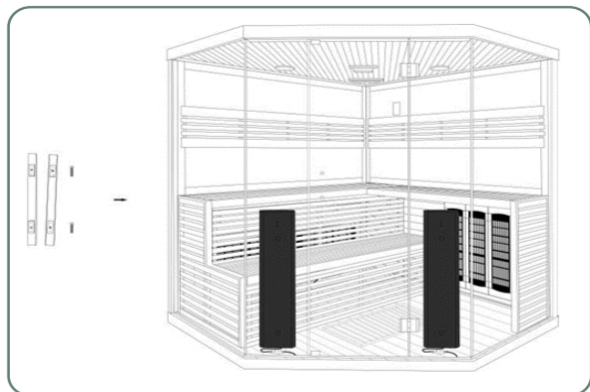

**STEP 12. INSTALLING THE WATERPROOF COVER**

Install the waterproof cover on the outside of the power interface to prevent water from entering.

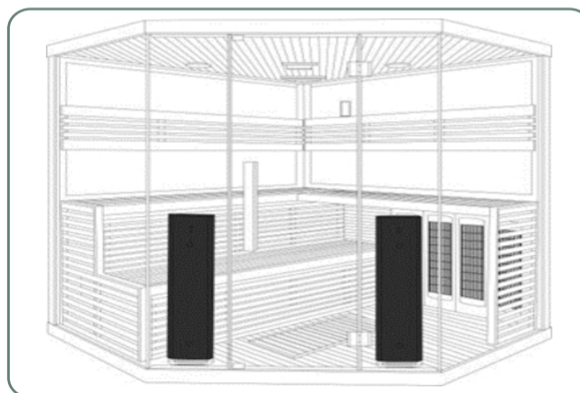
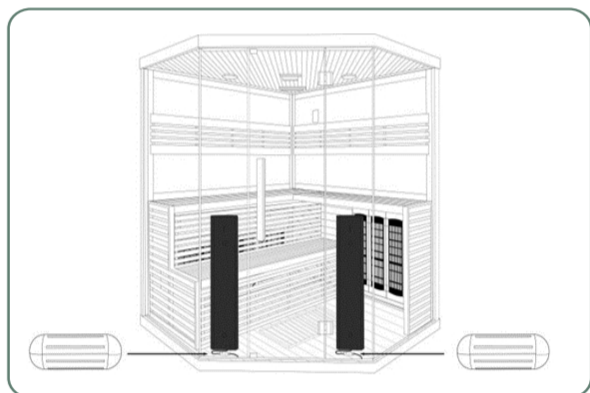

## Instructions for Use.

---

**Review all health and safety instructions. Please consult with your physician prior to using the sauna for any health concerns. If you feel light-headed or heat-exhausted during a session, exit the sauna immediately.**

1. Set the temperature to a comfortable level, normally, 40-50°C.
2. Allow approximately 8-15 minutes for the sauna to warm up before beginning a session.
3. Perspiration will start within 6 to 15 minutes after stepping into the unit. We recommend that a sauna session does not exceed 30 minutes.
4. When the temperature reaches the level set on the thermostat, the heaters will turn off and on periodically to maintain the desired temperature level inside the sauna.
5. The front door/window and/or ceiling vent can be opened at any time to introduce fresh air into the sauna.
6. Infrared's unique property of direct penetration into the body without heating the intervening air in-between allows sauna users to enjoy all of its benefits while the door or window of a sauna is open for ventilation.
7. Always drink plenty of water before, during, and after a sauna session. Doing so will replenish lost fluids from the body through perspiration.
8. Choosing to take a hot shower or bath prior to the sauna session will further promote perspiration. However, dry off thoroughly before going into the sauna because excessive water will stain or warp the wood. A shower after the session is refreshing and rinses perspiration from the body.
9. During the sauna session, keep the sauna tidy by placing a towel on the bench and the floor to absorb your perspiration. Keep one towel handy to wipe off excess sweat from your body.

## Warning.

---

This appliance is not intended for use by persons (including children) with reduced physical, sensory or mental capabilities, or who lack the experience and knowledge, unless they have been given supervision or instruction concerning the use of the appliance by a person responsible for their safety. Children should be supervised to ensure that they do not play with the appliance.

## Tips for use.

---

1. To regulate the temperature inside the sauna during your session, use the roof vent or the door window (by setting it at an angle).
2. If you feel the need for more cooling, simply leave the door open until the air around you feels comfortable enough.
3. Drink plenty of fluids prior to, during, and after your session.
4. If you take a hot/warm shower or bath before your sauna session, you may perspire more. Try it with and without bathing or showering first to determine which way you prefer.
5. To utilise the sauna's heat therapy effect, give your hair a hot oil treatment while in the sauna. Put oil or treatment into your hair and wrap it with towel. After the session is over, rinse your hair thoroughly.
6. Use at least 2-3 towels. Sit on one towel folded over several times for added cushioning. Put another towel on the floor to absorb extra sweat. A third towel draped over the knees may aid you in comfort and is useful to towel off sweat.
7. Be sure to towel off excess sweat during your session to help the body perspire more freely.
8. To help relieve sore and tense muscles, massage the affected areas while in sauna to help heal faster.
9. Shaving your face or legs with a razor while profusely sweating in a sauna yields an incredibly smooth result without the use of gels or foams.
10. Do not eat anything at least an hour before your sauna session. It is better to go in the sauna on an empty stomach. You are more likely to feel uncomfortable sitting in a sauna with a full stomach.
11. To make the most out of your sauna session, work your muscles while in the sauna. Stretch your arms and legs, massage your neck, massage your feet, etc.
12. You can benefit from the relaxing and soothing effects of a regular sauna session by going to sleep afterwards. The peaceful and relaxed state rendered by a sauna session will help you sleep easier and better.
13. At the first sign of cold or flu, increasing your sauna sessions may be beneficial in boosting your immune system and decreasing the reproductive rate of the viruses.
14. Consult your physician for the proper treatment for this or any other conditions.
15. To treat your ankles and feet more effectively, you must elevate them while inside the sauna. Any area that you wish to achieve a specific deep heating effect in should be moved as close to one of the heaters as feels comfortable.
16. After the session is over, do not immediately jump into the shower. Since your body was heated up during the session, it will continue to sweat even after the session. Sit in the sauna with the door open and let the body sweat a little more while it cools off. After you feel comfortable enough, take a warm shower and finish it off with a cold shower to cool off completely.

## Safety Instruction.

---

1. Read and follow all instructions carefully.
2. When installing and using this electrical equipment, you should always follow basic safety precautions.
3. Do not use the sauna immediately following strenuous exercise. Wait at least 30 minutes to allow the body to cool down completely.

### Safety precautions

- a. To avoid fire, do not dry clothes or leave any towels in the sauna.
- b. To prevent burns or electric shocks, do not touch or use metal tools on the net cover of the far infrared heater elements.
- c. While in the sauna, do not touch the light bulb. If the bulb needs to be changed, switch it off and wait until the sauna is shut off and the bulb is cool.
- d. Do not spray water on the far infrared tube. This activity may result in electric shock or damage to the heater elements.
- e. For the safety and well-being of everyone, listed below are precautions when using the sauna:
  - 1) For Individuals with Certain Medical Conditions: Saunas increase body temperature and heart rate, which may not be suitable for individuals with:
    - Heart disease or other cardiovascular conditions
    - Respiratory issues, such as asthma
    - Kidney disorders
    - Diabetes or blood sugar-related conditions
    - Low or high blood pressurePlease consult a physician before using the sauna if you have any of these or other chronic health concerns.
  - 2) Pregnant Individuals: Saunas can raise body temperature to levels that may be unsafe during pregnancy, especially in its early stages. Always check with your doctor before use.
  - 3) Children and Elderly Individuals: Young children and older adults may be more sensitive to heat. Children under 12 should not use the sauna unless under close supervision, and only for short periods. Elderly users should consult their healthcare provider and start with lower temperatures and shorter sessions.
  - 4) Individuals Under the Influence of Alcohol or Drugs: Alcohol and certain medications can impair judgment, increase dehydration, and raise the risk of overheating. Please avoid using the sauna while under the influence of any substances that may affect your awareness or body temperature regulation.
  - 5) Those Feeling Unwell: If you have fever, flu symptoms, or any form of infection, wait until you are fully recovered before using the sauna. Saunas can place additional stress on the immune system.
  - 6) Individuals with Open Wounds or Skin Conditions: Saunas can aggravate certain skin conditions or delay healing of open wounds. Consult a dermatologist if you have skin sensitivities or chronic conditions like eczema or psoriasis.

These precautions are intended to ensure a safe and enjoyable sauna experience for everyone. Always seek medical advice before using the sauna.

## Disclaimer.

---

Please read the following disclaimer carefully before purchasing or using our sauna product. By proceeding with the purchase or use of our sauna, you acknowledge that you have read, understood, and agreed to the terms and conditions outlined below:

### **Health Considerations**

Our sauna is designed to provide relaxation and promote overall wellbeing.

However, it is essential to consult with a healthcare professional before using the sauna if you have any underlying health conditions, including but not limited to cardiovascular problems, high blood pressure, respiratory issues, diabetes, or any other medical concerns. Pregnant women and individuals under the age of 18 should also seek medical advice before using the sauna.

### **Proper Usage**

Our sauna should be used strictly in accordance with the manufacturer's instructions and guidelines. Failure to follow the provided instructions may result in personal injury, property damage, or adverse health effects. The sauna should be used in a well-ventilated area and for the recommended duration specified by the manufacturer. Overexposure to heat can be hazardous and cause overheating or dehydration.

### **Safety Precautions**

It is important to take appropriate safety precautions while using the sauna. Do not use the sauna under the influence of alcohol, drugs, or any other substances that may impair judgment or increase the risk of accidents. Never leave the sauna unattended while it is in operation, especially if there are children or vulnerable individuals present. Keep flammable materials away from the sauna and ensure there is sufficient space around it to prevent fire hazards.

### **Maintenance and Care**

Regular maintenance and cleaning of the sauna are necessary to ensure its optimal performance and longevity. Always follow the manufacturer's instructions for cleaning and maintenance procedures. Failure to maintain the sauna properly may lead to malfunctioning or safety hazards. If you notice any signs of damage or malfunction, discontinue use and contact our customer support immediately.

### **Limitation of Liability**

We strive to provide a high quality and safe product, but we cannot be held responsible for any direct or indirect damages, injuries, or accidents resulting from the purchase, installation, or use of our sauna. The buyer assumes all responsibility and liability associated with the use of the sauna.

### **Legal Compliance**

It is the buyer's responsibility to ensure compliance with all applicable laws, regulations, and local building codes regarding the installation, operation, and use of the sauna. Any modifications or alterations made to the sauna without prior authorization from the manufacturer may void the warranty and could compromise its safety.

*It is strongly recommended to seek professional advice or assistance whenever necessary to ensure safe and proper use of the product.*

***Again, we thank you for your purchase.  
You've made our day, and we hope you have a great one too!  
Enjoy your sauna!***

For any questions, please call us at 02 8899 1114 or contact our  
online customer service team through our website.

**LUXO|Saunas**